

# User Guide

**Tenda**



2.4G Long Range  
Outdoor Access Point

# Copyright Statement

© 2015 Shenzhen Tenda Technology Co., Ltd. All rights reserved.

Tenda is a registered trademark legally held by Shenzhen Tenda Technology Co., Ltd. Other brand and product names mentioned herein are trademarks or registered trademarks of their respective holders. Copyright of the whole product as integration, including its accessories and software, belongs to Shenzhen Tenda Technology Co., Ltd. No part of this publication can be reproduced, transmitted, transcribed, stored in a retrieval system, or translated into any language in any form or by any means without the prior written permission of Shenzhen Tenda Technology Co., Ltd.

# Disclaimer

Pictures, images and product specifications herein are for references only. To improve internal design, operational function, and/or reliability, Tenda reserves the right to make changes to the products without obligation to notify any person or organization of such revisions or changes. Tenda does not assume any liability that may occur due to the use or application of the product described herein. Every effort has been made in the preparation of this document to ensure accuracy of the contents, but all statements, information and recommendations in this document do not constitute the warranty of any kind, express or implied.



# Conventions

Thank you for choosing Tenda! Please read this user guide before you start. This user guide instructs you to install and configure the AP.

Typographical conventions in this User Guide:

| Item             | Presentation | Example  |
|------------------|--------------|--|
| Button           | Bold         | “Click the Save button” can be simplified as “Click <b>Save</b> ”. |
| Menu             | Bold         | “The menu Basic” can be simplified as <b>Basic</b> .               |
| Continuous Menus | >            | Click <b>Wireless &gt; Basic</b>                                   |

Symbols in this User Guide:

| Item  | Meaning  |
|---|--|
|  <b>Note</b> | This format is used to highlight information of importance or special interest. Ignoring this type of note may result in ineffective configurations, loss of data or damage to device. |
|  <b>Tip</b>  | This format is used to highlight a procedure that will save time or resources.   |

# Contents

|   |           |
|---|-----------|
| <b>1 Product Overview .....</b>                     | <b>1</b>  |
| Package Contents .....                              | 1         |
| Hardware Description .....                          | 2         |
| Front View.....                                     | 2         |
| Rear View.....                                      | 3         |
| Label .....   | 4         |
| <b>2 Quick Installation Guide .....</b>             | <b>5</b>  |
| Step 1: Connect an Ethernet Cable to the AP.....    | 5         |
| Step 2: Install the AP.....                         | 5         |
| Step 3: Connect the PoE Injector .....              | 6         |
| Step 4: Quick Setup the AP .....                    | 6         |
| AP Mode .....                                       | 7         |
| Station (Client) Mode.....                          | 9         |
| Universal Repeater Mode.....                        | 11        |
| WISP Mode.....                                      | 14        |
| Repeater + P2MP Mode .....                          | 16        |
| Router.....   | 22        |
| <b>3 Advanced Settings.....</b>                     | <b>25</b> |
| Status.....   | 25        |
| Quick Setup.....                                    | 27        |
| Network.....  | 27        |
| How to Change the LAN IP Address .....              | 27        |
| How to Configure DHCP Server Settings .....         | 29        |
| How to View DHCP Client Info.....                   | 30        |
| How to Clone MAC Address .....                      | 31        |
| Wireless.....                                       | 32        |
| How to Configure Basic Wireless Settings .....      | 32        |
| How to Configure Advanced Wireless Settings .....   | 34        |
| How to Filter Access to Your Network .....          | 36        |
| Advanced .....                                      | 37        |
| How to Set LAN Rate .....                           | 37        |
| How to Diagnose Your Network .....                  | 38        |
| How to Reboot Your AP Regularly .....               | 41        |
| How to Log in to Web UI in a More Secure Way .....  | 42        |
| How to Configure the Idle Timeout .....             | 42        |
| How to Configure SNMP Settings .....                | 43        |
| How to Manage Your Device via Telnet .....          | 43        |
| How to Enable the UPNP Settings.....                | 44        |
| How to Prioritize Your Network Bandwidth Usage..... | 44        |

---

|   |           |
|---|-----------|
| How to Visit the Intranet Resource from the Internet by Configuring Port Forwarding Settings..... | 45        |
| How to Filter Internet Access via MAC Addresses.....  | 47        |
| How to Configure DDNS Settings.....   | 49        |
| How to Manage the Device Remotely .....   | 51        |
| Tools.....  | 52        |
| How to Configure System Time for Your Device .....  | 52        |
| How to Reboot your AP Manually.....   | 53        |
| How to Reset Your AP .....  | 54        |
| How to Upgrade Your AP .....  | 54        |
| How to Backup and Restore Your AP's Configurations.....   | 55        |
| How to Change Your Login Account .....  | 56        |
| How to View the History of Your AP's Actions .....  | 58        |
| <b>Appendix.....</b>  | <b>59</b> |
| 1 Configure PC .....  | 59        |
| Windows 8 .....   | 59        |
| Windows 7 .....   | 61        |
| Windows XP .....  | 63        |
| 2 Connect to Your WiFi.....   | 65        |
| Windows 8 .....   | 65        |
| Windows 7 .....   | 66        |
| Windows XP .....  | 68        |
| 3 FAQs .....  | 70        |
| 4 Safety and Emission Statement.....  | 70        |

# 1 Product Overview

Tenda O3 is an advanced and high-performance long-range wireless access point which is suitable for long-range data transmission and video surveillance, especially in WISP CPE solutions. Equipped with built-in 12dBi directional dual-polarized antenna, it offers high data transmission of up to 5km on 2.4GHz band with maximum transmission power of 800mW. With waterproof housing and flexible mounting design, it applies to different harsh environments and provides reliable, secure and wide wireless coverage.

## Package Contents



Long Range Outdoor Access Point \*1

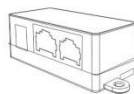

PoE Injector\*1



Power Adapter\*1



Screw\*2 (for fixing the PoE Injector)

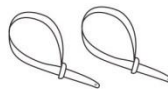

Plastic strap\*2



Ethernet Cable\*1



Screw Bolt\*2 (for fixing the PoE Injector)



Grounding Screw\*1



Install Guide\*1



GNU\*1

If any item is incorrect, missing, or damaged, please contact your dealer for immediate replacement.

## Hardware Description

### Front View

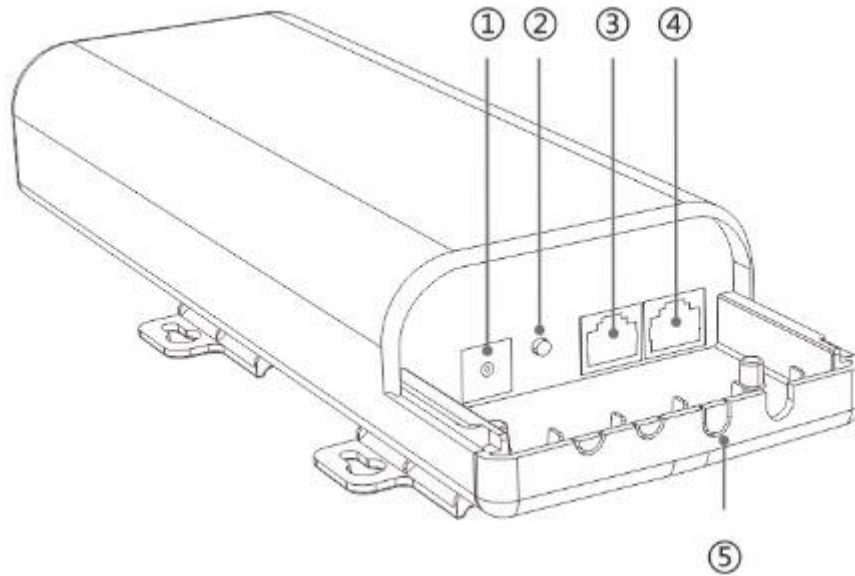

| Item | Port / Button | Description   |
|------|---------------|---|
| 1    | GND           | With the included grounding screw, attach a copper wire here to provide proper surge and lightning protection for your device.                                      |
| 2    | RST           | Pressing and holding the reset button for over 7 seconds restores this device to factory defaults.  |
| 3    | LAN           | A 100Mbps LAN port for connecting the Ethernet device such as a switch, a computer, etc.  |
| 4    | PoE LAN/WAN   | This port provides power over an Ethernet connection via the PoE injector. And it works interchangeably as a WAN port in Router mode and a LAN port in other modes. |
| 5    | /             | Cable access hole cut-outs  |

## Rear View

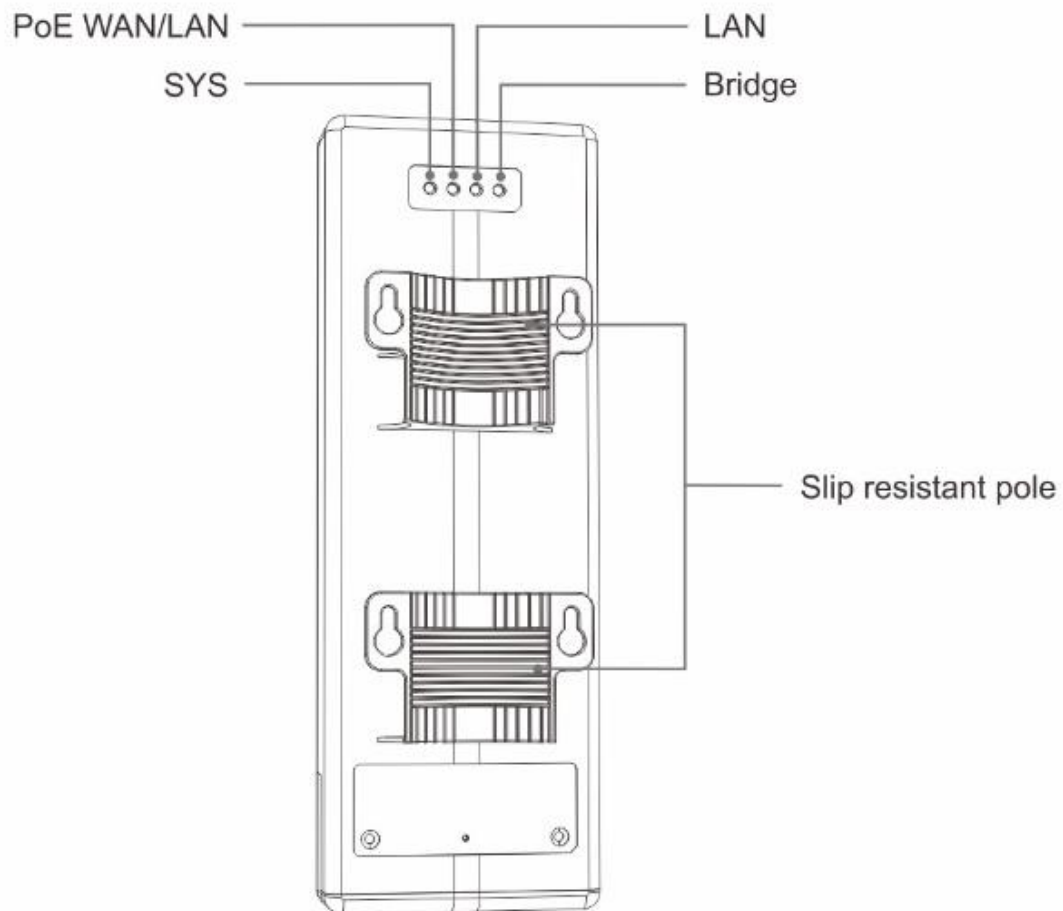

| LED            | Status   | Description  |
|----------------|----------|--|
| SYS            | Off      | Malfunction occurs or the device is not powered on.                  |
|                | Blinking | The device is working properly.                                      |
| PoE<br>WAN/LAN | Off      | There is no device linked to this port.                              |
|                | Solid    | There is a device linked to this port but no data transmission.      |
|                | Blinking | Data transmission is occurring on this port.                         |
| LAN            | Off      | There is no device linked to this port.                              |
|                | Solid    | There is a device linked to this port but no data transmission.      |
|                | Blinking | Data transmission is occurring on this port.                         |
| Bridge         | Off      | 1) Working in AP or Router mode<br>2) Failed to connect to remote AP |
|                | Solid    | Bridged to the remote AP successfully                                |



## Label

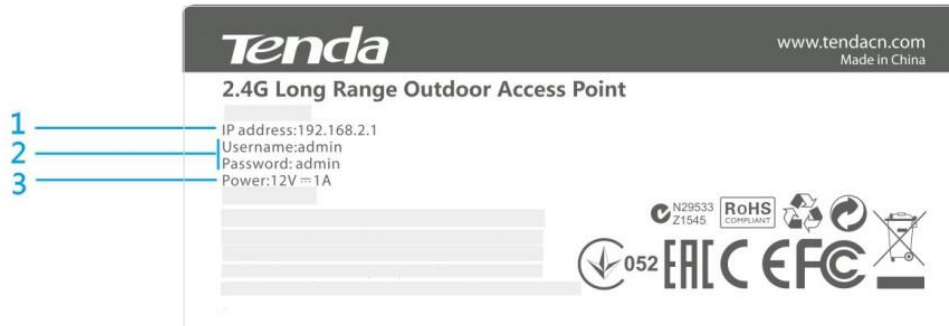

1. IP Address: Default login IP address for web login of this device.
2. Default login user name and password (admin for both).
3. Power specification of this device.

## 2 Quick Installation Guide

### Step 1: Connect an Ethernet Cable to the AP

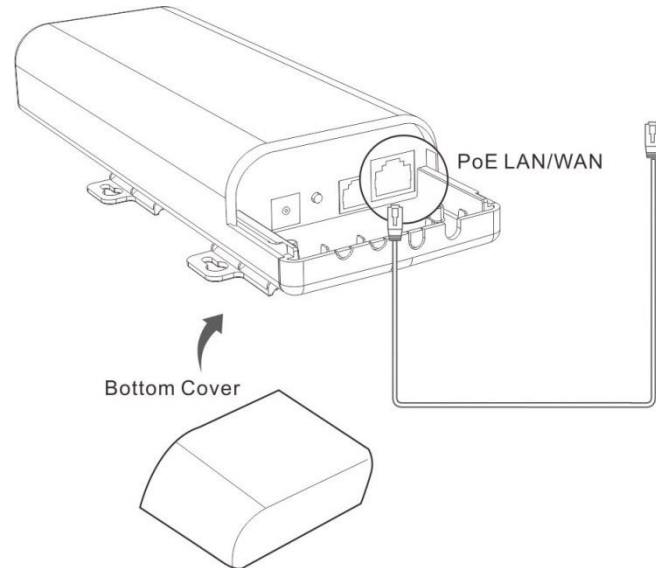

- 1 Slide the bottom cover of the AP down to expose the ports.
- 2 Connect an Ethernet cable ( $\leq 60\text{m}$ ), which will be connected to the PoE injector, to the **PoE LAN/WAN** port of your AP.
- 3 Gently replace the cover by sliding it up until it clicks into place.

### Step 2: Install the AP

Set up the AP in an outdoor location, usually on the roof, and thread plastic wraps through grooves underneath the brackets. Then attach the device firmly to a solid pole.

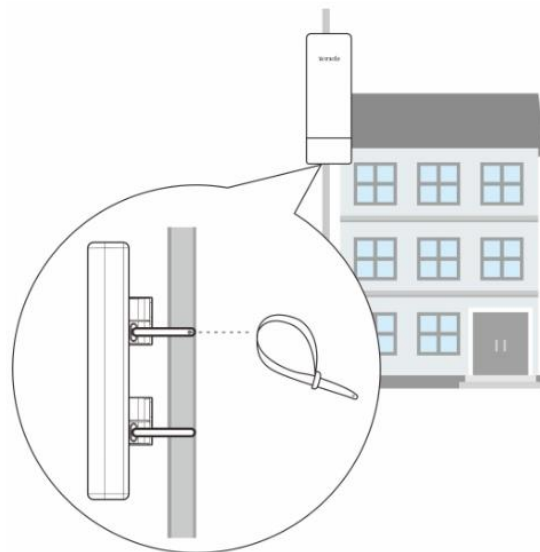

## Step 3: Connect the PoE Injector

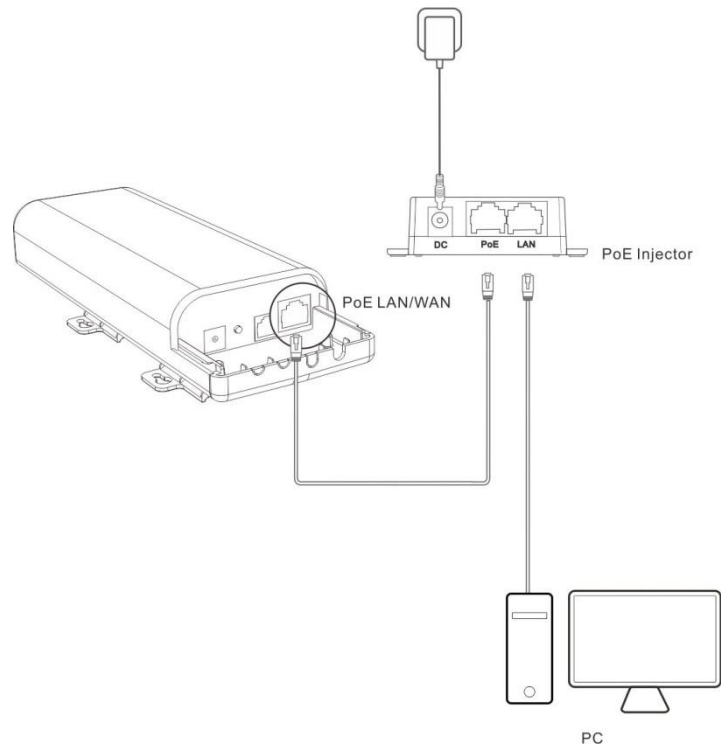

- 1 Connect the Ethernet cable in **Step 1** to the **PoE** port of the injector.
- 2 Connect your computer to the **LAN** port of the injector with another Ethernet cable.
- 3 Power on the AP by plugging the included power adapter into the **DC** jack on the injector, and the other end into a standard power outlet.

## Step 4: Quick Setup the AP

1. Verify that your PC is set to **Obtain an IP address automatically**.



### Tip

As the DHCP server of this AP is enabled by default, the first time you log in to this device from your PC, you only need to set your PC to **Obtain an IP address automatically**. Once you finished settings on **Quick Setup** page, the DHCP server will be disabled. At this time, if you want to log in to its web UI, you need to specify an IP address manually to your PC. For specific steps, see Appendix [1 Configure PC](#).

- Input **192.168.2.1** in a web browser's address bar, and then press **Enter** or **Return** on your keyboard.

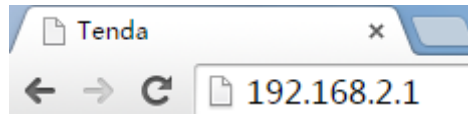

- Enter the default username and password (**admin** for both defaults) and click **Login**.

A screenshot of the login page. It features three input fields: a username field with 'admin', a password field with masked characters '....', and a location dropdown menu set to 'India'. Below these fields is an orange 'Login' button and a link that says 'Forget your password?'.

- Please select the proper operating mode and follow instructions on the web UI to apply your settings. 7 operating modes are supported on this AP: AP, Station (Client), Universal Repeater, WISP, Repeater, P2MP and Router.

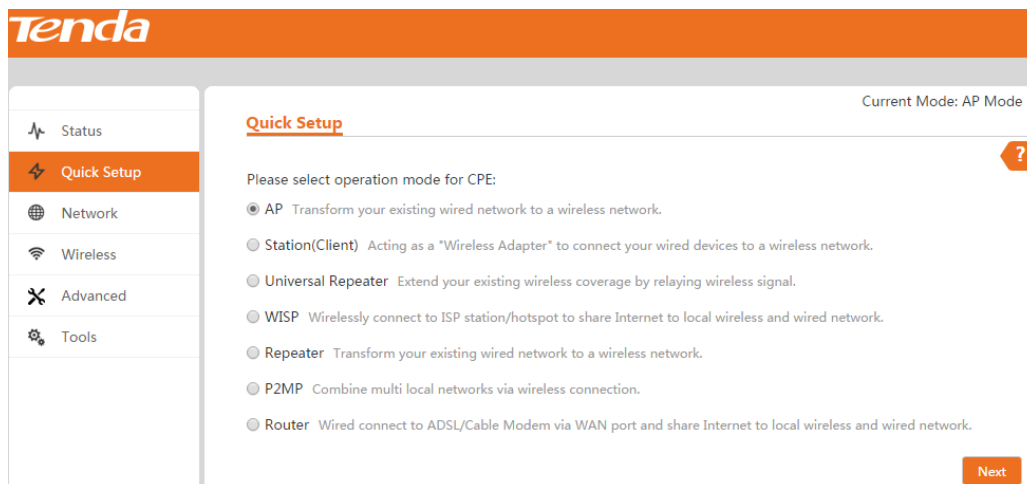

## AP Mode

In this mode, the device can be connected to a wired network and transform the wired access into wireless that multiple devices can share together.

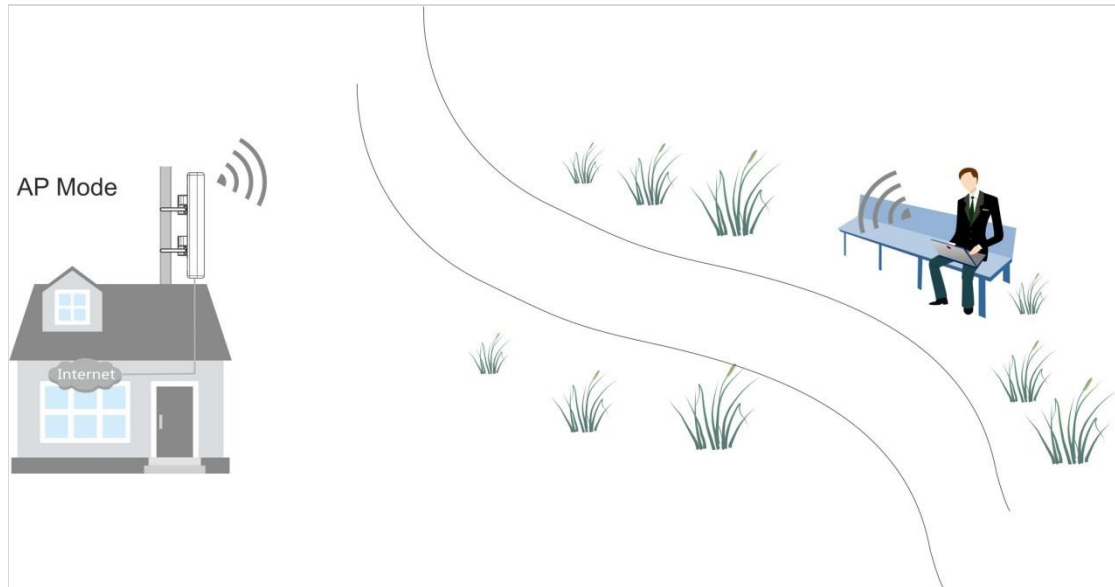

### Configuration Steps:

- 1 Select **AP** mode and click **Next**.

**Tenda**

Current Mode: AP Mode

**Quick Setup**

Please select operation mode for CPE:

- 1  **AP** Transform your existing wired network to a wireless network.
- Station(Client)** Acting as a "Wireless Adapter" to connect your wired devices to a wireless network.
- Universal Repeater** Extend your existing wireless coverage by relaying wireless signal.
- WISP** Wirelessly connect to ISP station/hotspot to share Internet to local wireless and wired network.
- Repeater** Combine multi networks via wireless connection.
- P2MP** Combine multi local networks via wireless connection.
- Router** Wired connect to ADSL/Cable Modem via WAN port and share Internet to local wireless and wired network.

**2** Next

- 2 Customize SSID (WiFi name), set wireless security settings (Recommended: WPA-PSK, AES) for your local network and then click **Next**.

**Tenda**

Current Mode: AP Mode

**Quick Setup >> AP**

This sector is used to set wireless network name and wireless password for your local network, please remember the wifi password.

① SSID: Tenda\_000030  
Channel: Auto

② Security Mode: WPA-PSK  
Encryption Type:  AES  TKIP  TKIP&AES  
WiFi Password: 12345678

Previous Next

③ Click **Save** to apply your changes. Wait until the device restarts automatically.

**Tenda**

Current Mode: AP Mode

**Quick Setup >> AP**

You are configuring the device to work as AP mode. If you have confirmed settings, please click Save to reboot the device and activate the configuration.

Previous Save

## Station (Client) Mode

In this mode, the device can be connected to another device via an Ethernet port and act as an adapter to grant your wired devices access to a wireless network, especially for data transmission or video surveillance.



## Configuration Steps:

- 1 Select **Station (Client)** mode and click **Next**.

The screenshot shows the Tenda Quick Setup page. The left sidebar contains navigation options: Status, Quick Setup (selected), Network, Wireless, Advanced, and Tools. The main content area is titled "Quick Setup" and shows "Current Mode: AP Mode". Below the title, it asks to "Please select operation mode for CPE:" and lists several options with radio buttons:

- AP Transform your existing wired network to a wireless network.
- Station(Client)** Acting as a "Wireless Adapter" to connect your wired devices to a wireless network.
- Universal Repeater Extend your existing wireless coverage by relaying wireless signal.
- WISP Wirelessly connect to ISP station/hotspot to share Internet to local wireless and wired network.
- Repeater Combine multi networks via wireless connection.
- P2MP Combine multi local networks via wireless connection.
- Router Wired connect to ADSL/Cable Modem via WAN port and share Internet to local wireless and wired network.

At the bottom right, there is a "Next" button with a blue circle containing the number 2.

- 2 Select the SSID (WiFi name) you wish to connect to and click **Next**.

The screenshot shows the Tenda Quick Setup page, now titled "Quick Setup >> Station". It shows "Current Mode: AP Mode". Below the title, it asks to "Please switch on Scan button or click Rescan to scan the wireless signal, then select the remote AP you want to connect, and click Next to continue." There is a "Scan" button (disabled) and a "Rescan" button.

Below that, there is a "Remote SSID" input field containing "Tenda\_1C8110".

A table lists the scanned wireless signals:

| Select                           | SSID         | Channel | MAC Address       | Encryption  | Signal Strength |
|----------------------------------|--------------|---------|-------------------|-------------|-----------------|
| <input checked="" type="radio"/> | Tenda_1C8110 | 2       | C8:3A:35:00:9C:E0 | wpa2psk/aes |                 |

- 3 Enter the key (WiFi password) of the remote device and click **Next**.

The screenshot shows the Tenda Quick Setup page, now titled "Quick Setup >> Station". It shows "Current Mode: AP Mode". Below the title, it asks to "Please keep Channel, Security mode, Encryption Type, Frequency bandwidth the same with remote AP, then enter the remote AP's wifi password, and click Next to continue." There are several input fields:

- Remote AP: Tenda\_1C8110
- Remote AP MAC: C8:3A:35:00:9C:E0
- Channel: Channel 2 (2417MHz)
- Security Mode: WPA2-PSK
- Encryption Type:  AES  TKIP  TKIP&AES
- Key:

At the bottom right, there are "Previous" and "Next" buttons. The "Next" button has a blue circle containing the number 2.

- 4 Make sure that the IP address is different from that of the remote device but on the same network segment and then click **Next**.

**Tenda**

Current Mode: AP Mode

**Quick Setup >> Station**

Please make sure the IP address is different from remote AP's IP address but in the same network segment.

|                      |  |
|----------------------|--|
| IP Address           | <input type="text" value="192.168.2.10"/>  |
| Subnet Mask          | <input type="text" value="255.255.255.0"/> |
| Default Gateway      | <input type="text" value="192.168.2.254"/> |
| Preferred DNS Server | <input type="text" value="192.168.2.254"/> |
| Alternate DNS Server | <input type="text" value="8.8.4.4"/>       |

- 5 Click **Save** to apply your changes. Wait until the device restarts automatically.

When the **Bridge** LED stays solid, it has been bridged successfully!

**Tenda**

Current Mode: AP Mode

**Quick Setup >> Station**

You are configuring the device to work as Station mode. If you have confirmed settings, please click Save to reboot the device and activate the configuration.

## Universal Repeater Mode

In this mode, the device extends the wireless coverage of another wireless AP or router. The advantage of the universal repeater is that the remote device does not need to have WDS function and may not need to be the same brand. Therefore, it can work with almost any wireless device.



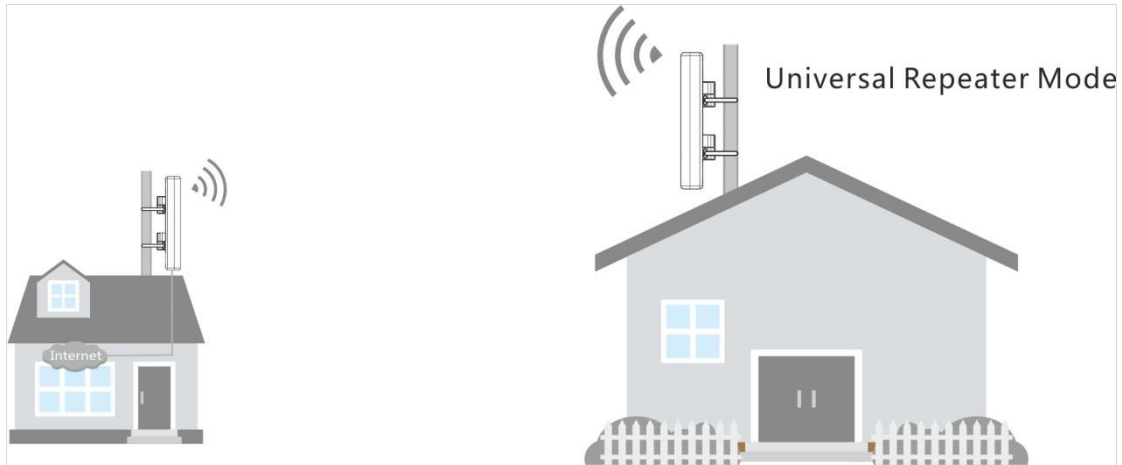

**Configuration Steps:**

**1** Select **Universal Repeater** mode and click **Next**.

**Tenda** Current Mode: AP Mode

**Quick Setup** ?

Please select operation mode for CPE:

- AP Transform your existing wired network to a wireless network.
- Station(Client) Acting as a "Wireless Adapter" to connect your wired devices to a wireless network.
- 1**  **Universal Repeater** Extend your existing wireless coverage by relaying wireless signal.
- WISP Wirelessly connect to ISP station/hotspot to share Internet to local wireless and wired network.
- Repeater Combine multi networks via wireless connection.
- P2MP Combine multi local networks via wireless connection.
- Router Wired connect to ADSL/Cable Modem via WAN port and share Internet to local wireless and wired network.

2 **Next**

**2** Select the SSID (WiFi name) you wish to connect to and click **Next**.

**Tenda** Current Mode: AP Mode

**Quick Setup >> Universal Repeater**

Please switch on Scan button or click Rescan to scan the wireless signal, then select the remote AP you want to connect, and click Next to continue.

Scan  [Rescan](#)

Remote SSID

| Select                           | SSID         | Channel | MAC Address       | Encryption  | Signal Strength |
|----------------------------------|--------------|---------|-------------------|-------------|-----------------|
| <input type="radio"/>            | Tenda_1C8110 | 13      | 00:B0:0C:1C:81:09 | none        |                 |
| <input checked="" type="radio"/> | Tenda_888888 | 13      | C8:3A:35:12:34:B0 | wpa2psk/aes |                 |

- 3 Enter the key (WiFi password) of the remote SSID and click **Next**.

- 4 Make sure that the IP address is different from that of the remote device but on the same network segment and then click **Next**.

- 5 Click **Save** to apply your changes. Wait until the device restarts automatically.

When the **Bridge** LED stays solid, it has been bridged successfully!

## WISP Mode

In this mode, the device connects to ISP hotspot wirelessly to share Internet with local devices.

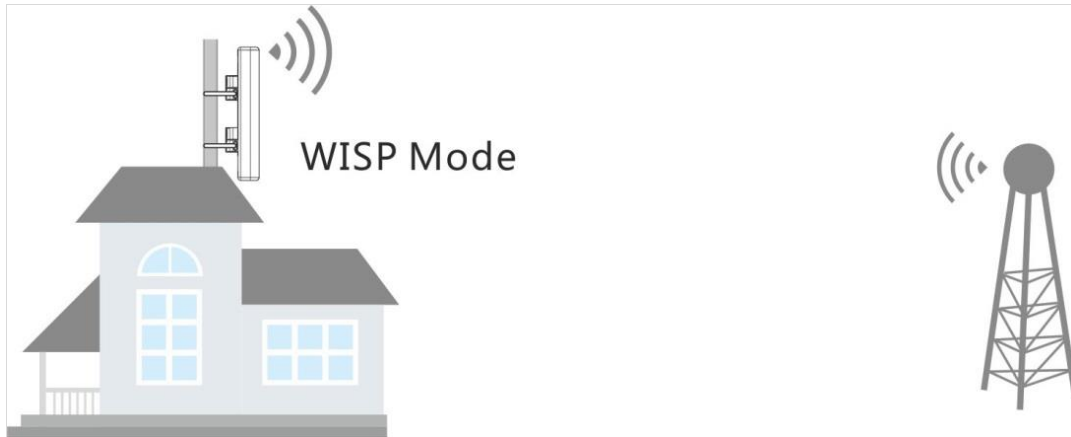

### Configuration Steps:

- 1 Select **WISP** mode and click **Next**.

The screenshot shows the Tenda web interface. On the left is a navigation menu with 'Quick Setup' selected. The main content area is titled 'Quick Setup' and shows 'Current Mode: AP Mode'. Below the title, it asks to 'Please select operation mode for CPE:' and lists several options: AP, Station(Client), Universal Repeater, WISP (selected), Repeater, P2MP, and Router. A 'Next' button is visible at the bottom right.

- 2 Select the SSID (WiFi name) you wish to connect to and click **Next**.

The screenshot shows the Tenda web interface at the 'Quick Setup >> WISP' page. It prompts the user to 'Please switch on Scan button or click Rescan to scan the wireless signal, then select the remote AP you want to connect, and click Next to continue.' There is a 'Scan' button (disabled) and a 'Rescan' button. Below, the 'Remote SSID' field contains 'Tenda\_1C8100'. A table of detected wireless signals is shown:

| Select                           | SSID         | Channel | MAC Address       | Encryption  | Signal Strength |
|----------------------------------|--------------|---------|-------------------|-------------|-----------------|
| <input checked="" type="radio"/> | Tenda_1C8110 | 13      | C8:3A:35:00:00:10 | wpa2psk/aes |                 |

- 3 Enter the key (WiFi password) of the remote SSID if needed and click **Next**.

**Tenda**

Current Mode: AP Mode

**Quick Setup >> WISP**

Please keep Channel, Security mode, Encryption Type, Frequency bandwidth the same with remote AP, then enter the remote AP's wifi password, and click Next to continue.

Remote AP: Tenda\_1C8110

Remote AP MAC: C8:3A:35:00:00:10

Channel: Channel 13 (2472MHz)

Security Mode: WPA2-PSK

Encryption Type:  AES  TKIP  TKIP&AES

1 Key:

Previous Next

- 4 Select the WAN connection type, set corresponding parameters if needed and click **Next**.

**Tenda**

Current Mode: AP Mode

**Quick Setup >> WISP**

Please select WAN connection type, then enter the PPPoE account or ip address provided by ISP, and click Next to continue.

WAN Connection Type:  DHCP(Dynamic IP)  Static IP  PPPoE

Previous Next

- 5 Customize the SSID (WiFi name) and wireless security settings (Recommended: WPA2-PSK, AES) for your local network, and then click **Next**.

**Tenda**

Current Mode: AP Mode

**Quick Setup >> WISP**

This sector is used to set wireless network name and wireless password for your local network, please remember the wifi password.

1 SSID: Tenda\_002160

Channel: Channel 13 (2472MHz)

Security Mode: WPA2-PSK

Encryption Type:  AES  TKIP  TKIP&AES

2 Wifi Password: 12345678

Previous Next

6 Make sure that the IP address is different from that of ISP hotspot and on the different network segment. For example, if the ISP hotspot's IP address is 192.168.2.x, this AP's IP can be 192.168.5.x.

7 Click **Save** to apply your changes. Wait until the device restarts automatically.

When the **Bridge** LED stays solid, it has been bridged successfully!

## Repeater + P2MP Mode

Both the Repeater mode and P2MP mode support point-to-multipoint bridge connection. Only the base device and remote device scan each other and keep their SSIDs, channels, security modes and keys the same, can they bridge successfully. However, in P2MP mode, wireless clients are not allowed to connect to the device itself. The device only works as a repeater to relay wireless signal.

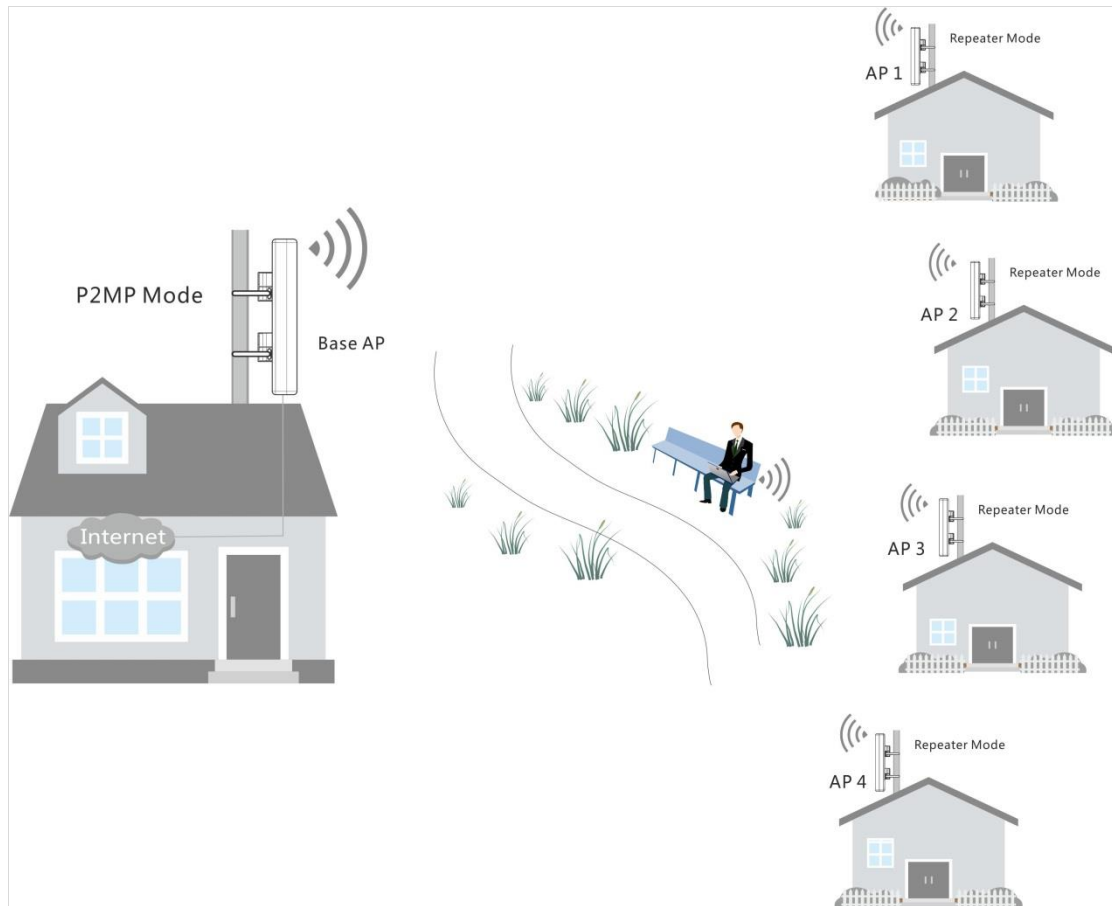

Before configuring Repeater + P2MP settings, verify the following information:

| AP      | Mode     | SSID         | MAC Address       | Key      |
|---------|----------|--------------|-------------------|----------|
| Base AP | P2MP     | Tenda_002160 | C8:3A:35:00:21:61 | 11111111 |
| AP1     | Repeater | Tenda_000050 | C8:3A:35:00:00:51 | 11111111 |
| AP2     |          | Tenda_000020 | C8:3A:35:00:00:21 | 11111111 |
| AP3     |          | Tenda_130507 | C8:3A:35:13:05:08 | 11111111 |
| AP4     |          | Tenda_4EF409 | C8:3A:35:4E:F4:10 | 11111111 |

**! Note:**

1. As for IP addresses, they should not be the same but on the same network segment.
2. The base AP's and the remote device's SSIDs, channels, security modes and keys should be kept the same.
3. Up to 4 APs can be bridged at the same time both for both the Repeater and P2MP mode.

### Configuration Steps:

- a. Repeat following steps to set AP1, AP2, AP3 and AP4 in Repeater mode to bridge with the base AP respectively

- 1 Select **Repeater** mode on the **Quick Setup** page and click **Next**.

The screenshot shows the Tenda Quick Setup interface. The left sidebar contains navigation options: Status, Quick Setup (selected), Network, Wireless, Advanced, and Tools. The main content area is titled "Quick Setup" and shows "Current Mode: AP Mode". Below the title, there is a list of operation modes for the CPE:

- AP Transform your existing wired network to a wireless network.
- Station(Client) Acting as a "Wireless Adapter" to connect your wired devices to a wireless network.
- Universal Repeater Extend your existing wireless coverage by relaying wireless signal.
- WISP Wirelessly connect to ISP station/hotspot to share Internet to local wireless and wired network.
- Repeater Combine multi networks via wireless connection.
- P2MP Combine multi local networks via wireless connection.
- Router Wired connect to ADSL/Cable Modem via WAN port and share Internet to local wireless and wired network.

At the bottom right, there is a "Next" button.

- 2 Select the SSID of base AP you want to connect to and click **Next**.

The screenshot shows the Tenda Quick Setup >> Repeater interface. The left sidebar is the same as in the previous screenshot. The main content area is titled "Quick Setup >> Repeater" and shows "Current Mode: AP Mode". Below the title, there is a "Scan" button (disabled) and a "Rescan" link. Below that, there are four input fields for "Remote AP MAC 1" through "Remote AP MAC 4". The first field contains the MAC address "C8:3A:35:00:21:61". Below the input fields is a table of detected wireless networks:

| Select                           | SSID         | Channel | MAC Address       | Encryption  | Signal Strength |
|----------------------------------|--------------|---------|-------------------|-------------|-----------------|
| <input checked="" type="radio"/> | Tenda_002160 | 2       | C8:3A:35:00:21:61 | wpa2psk/aes |                 |
| <input type="radio"/>            | Tenda_1C8110 | 13      | 00:B0:0C:1C:81:09 | none        |                 |

- 3 Enter the key of the base AP and click **Next**.

The screenshot shows the Tenda Quick Setup interface for Repeater mode. The left sidebar contains navigation options: Status, Quick Setup (selected), Network, Wireless, Advanced, and Tools. The main content area is titled "Quick Setup >> Repeater" and indicates "Current Mode: AP Mode". The instructions state: "Please keep Channel, Security mode, Encryption Type, Frequency bandwidth the same with remote AP, then enter the remote AP's wifi password, and click Next to continue." The configuration fields are: Channel (Channel 2 (2417MHz)), Security Mode (WPA2-PSK), Encryption Type (AES selected, TKIP and TKIP&AES unselected), and Key (11111111). There are "Previous" and "Next" buttons at the bottom right.

- 4 Make sure the IP address is different from the base AP's IP address but on the same network segment and click **Next**. In this example, the base AP's IP address is 192.168.2.1, and you can set IP addresses of AP1, AP2, AP3 and AP4 to 192.168.2.3, 192.168.2.4, 192.168.2.5 and 192.168.2.6 respectively.

The screenshot shows the Tenda Quick Setup interface for Repeater mode, specifically the IP configuration step. The left sidebar is the same as in the previous screenshot. The main content area is titled "Quick Setup >> Repeater" and indicates "Current Mode: AP Mode". The instructions state: "Please make sure the IP address is different from remote AP's IP address but in the same network segment." The configuration fields are: IP Address (192.168.2.3), Subnet Mask (255.255.255.0), Default Gateway (192.168.2.254), Preferred DNS Server (192.168.2.254), and Alternate DNS Server (8.8.4.4). There are "Previous" and "Next" buttons at the bottom right.

- 5 Click **Save** to apply your changes. Wait until the device restarts automatically.

The screenshot shows the final step of the Tenda Quick Setup interface for Repeater mode. The left sidebar is the same. The main content area is titled "Quick Setup >> Repeater" and indicates "Current Mode: AP Mode". The instructions state: "You are configuring the device to work as Repeater mode. If you have confirmed settings, please click Save to reboot the device and activate the configuration." There are "Previous" and "Save" buttons at the bottom right.



6 Then you can go to the **Status** page to view that its SSID is identical with the base AP's, which indicates that this AP has bridged with the base AP successfully.

**Tenda**

**Status**

**System Info**

|                  |                     |
|------------------|---------------------|
| Device Name      | O3V1.0              |
| Running Time     | 7m 8s               |
| System Time      | 2015-08-11 14:24:00 |
| Firmware Version | V1.0.0.2(1578)      |

**Wireless Info**

|                   |              |
|-------------------|--------------|
| Working Mode      | Repeater     |
| SSID              | Tenda_002160 |
| Security Mode     | WPA2-PSK     |
| Channel/Bandwidth | 2/2417       |
| Wireless Clients  | 0            |

b. Set the base AP in P2MP mode and bridge with AP1, AP2, AP3 and AP4.

1 Select **P2MP** mode on the **Quick Setup** page and click **Next**.

**Tenda**

**Quick Setup** Current Mode: AP Mode

Please select operation mode for CPE:

- AP Transform your existing wired network to a wireless network.
- Station(Client) Acting as a "Wireless Adapter" to connect your wired devices to a wireless network.
- Universal Repeater Extend your existing wireless coverage by relaying wireless signal.
- WISP Wirelessly connect to ISP station/hotspot to share Internet to local wireless and wired network.
- Repeater Combine multi networks via wireless connection.
- P2MP Combine multi local networks via wireless connection.
- Router Wired connect to ADSL/Cable Modem via WAN port and share Internet to local wireless and wired network.

Next

- 2 Select SSIDs of AP1, AP2, AP3 and AP4 one by one and click **Next**.

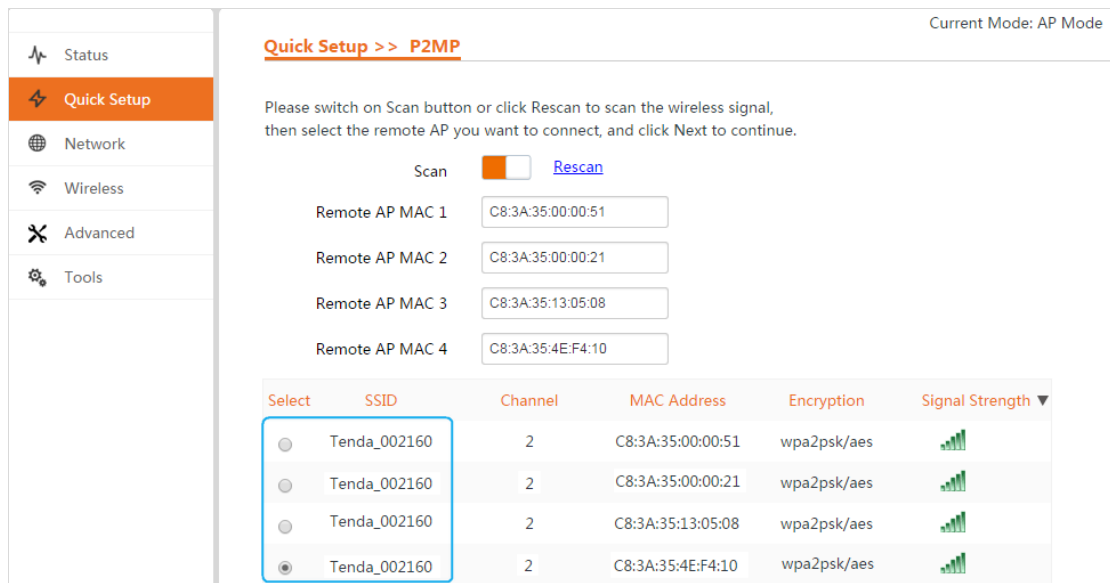

Quick Setup >> P2MP Current Mode: AP Mode

Please switch on Scan button or click Rescan to scan the wireless signal, then select the remote AP you want to connect, and click Next to continue.

Scan  [Rescan](#)

Remote AP MAC 1

Remote AP MAC 2

Remote AP MAC 3

Remote AP MAC 4

| Select                           | SSID         | Channel | MAC Address       | Encryption  | Signal Strength |
|----------------------------------|--------------|---------|-------------------|-------------|-----------------|
| <input type="radio"/>            | Tenda_002160 | 2       | C8:3A:35:00:00:51 | wpa2psk/aes |                 |
| <input type="radio"/>            | Tenda_002160 | 2       | C8:3A:35:00:00:21 | wpa2psk/aes |                 |
| <input type="radio"/>            | Tenda_002160 | 2       | C8:3A:35:13:05:08 | wpa2psk/aes |                 |
| <input checked="" type="radio"/> | Tenda_002160 | 2       | C8:3A:35:4E:F4:10 | wpa2psk/aes |                 |

- 3 Enter the key of the remote APs (Here these APs refer to AP1, AP2, AP3 and AP4) and click **Next**.

**Note:** As SSIDs, channels and security settings of all devices involved in both Repeater mode and P2MP mode need to be identical, and the remote APs have bridged to the base AP first, SSIDs and keys of all remote APs have been set to be identical with the base AP.

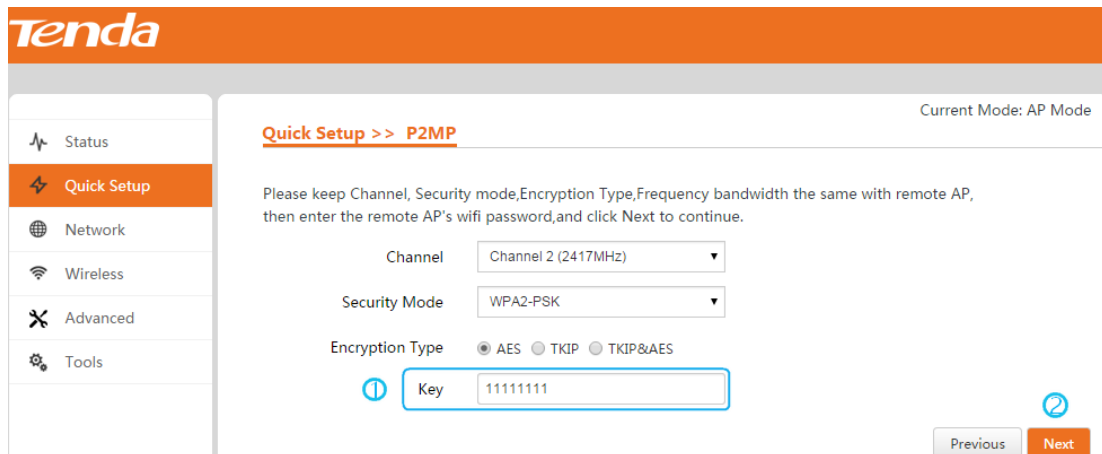

Tenda

Quick Setup >> P2MP Current Mode: AP Mode

Please keep Channel, Security mode, Encryption Type, Frequency bandwidth the same with remote AP, then enter the remote AP's wifi password, and click Next to continue.

Channel

Security Mode

Encryption Type  AES  TKIP  TKIP&AES

Key

- 4 Make sure the IP address is different from that of remote APs and click **Next**.

**Tenda**

Current Mode: AP Mode

**Quick Setup >> P2MP**

Please make sure the IP address is different from remote AP's IP address but in the same network segment.

IP Address: 192.168.2.1

Subnet Mask: 255.255.255.0

Default Gateway: 192.168.2.254

Preferred DNS Server: 192.168.2.254

Alternate DNS Server: 8.8.4.4

Previous Next

- 5 Click **Save** to apply your changes. Wait until the device restarts automatically.

When the **Bridge** LED stays solid, it has been bridged successfully!

**Tenda**

Current Mode: P2MP Mode

**Quick Setup >> P2MP**

You are configuring the device to work as P2MP mode. If you have confirmed settings, please click Save to reboot the device and activate the configuration.

Previous Save

## Router

In this mode, the device enables multi-users to share Internet via ADSL/Cable Modem. And the LAN port of the PoE injector works as the WAN port.

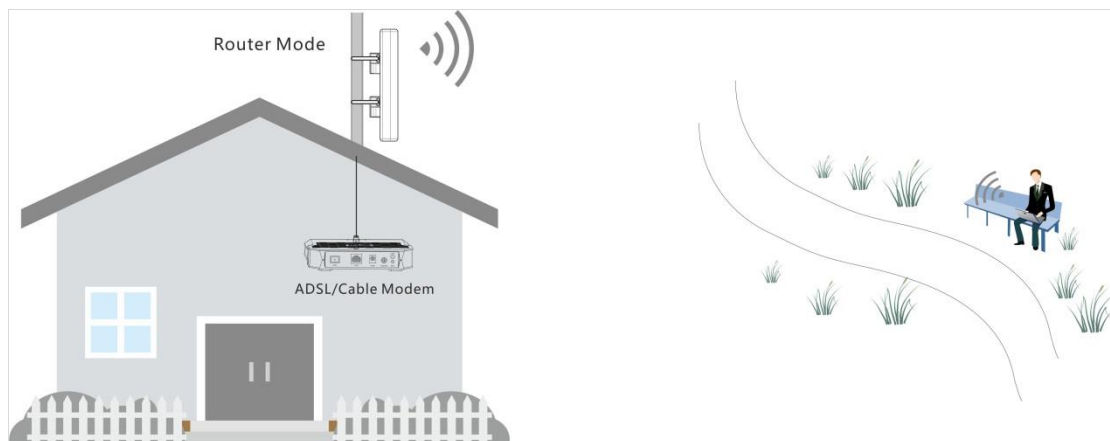

## Configuration Steps

- 1 Select **Router** mode and click **Next**.

The screenshot shows the Tenda Quick Setup interface. On the left is a navigation menu with options: Status, Quick Setup (highlighted), Network, Wireless, Advanced, and Tools. The main content area is titled "Quick Setup" and "Current Mode: AP Mode". It contains the instruction: "Please select operation mode for CPE:". Below this are several radio button options:
 

- AP: Transform your existing wired network to a wireless network.
- Station(Client): Acting as a "Wireless Adapter" to connect your wired devices to a wireless network.
- Universal Repeater: Extend your existing wireless coverage by relaying wireless signal.
- WISP: Wirelessly connect to ISP station/hotspot to share Internet to local wireless and wired network.
- Repeater: Combine multi networks via wireless connection.
- P2MP: Combine multi local networks via wireless connection.
- Router** (selected and circled in blue): Wired connect to ADSL/Cable Modem via WAN port and share Internet to local wireless and wired network.

 A "Next" button is located at the bottom right, with a blue circle containing the number 2 next to it.

- 2 Select the WAN connection type, set corresponding parameters if needed and click **Next**.

The screenshot shows the Tenda Quick Setup interface at the "Router" step. The navigation menu is the same. The main content area is titled "Quick Setup >> Router" and "Current Mode: AP Mode". It contains the instruction: "Please select WAN connection type, then enter the PPPoE account or ip address provided by ISP, and click Next to continue." Below this is the "WAN Connection Type" section with three radio button options:
 

- DHCP(Dynamic IP)** (selected)
- Static IP
- PPPoE

 At the bottom right, there are "Previous" and "Next" buttons. The "Next" button has a blue circle containing the number 2 next to it.

- 3 Customize the SSID (WiFi name) and wireless security settings (Recommended: WPA2-PSK, AES) for your local network, and then click **Next**.

The screenshot shows the Tenda Quick Setup interface at the "Router" step, specifically the wireless network configuration section. The navigation menu is the same. The main content area is titled "Quick Setup >> Router" and "Current Mode: AP Mode". It contains the instruction: "This sector is used to set wireless network name and wireless password for your local network, please remember the wifi password." Below this are several input fields:
 

- SSID** (circled in blue 1): Text input field containing "Tenda\_002160".
- Channel**: Dropdown menu set to "Auto".
- Security Mode**: Dropdown menu set to "WPA2-PSK".
- Encryption Type** (circled in blue 2): Radio button options for AES (selected), TKIP, and TKIP&AES.
- WiFi Password**: Text input field containing "12345678".

 At the bottom right, there are "Previous" and "Next" buttons. The "Next" button has a blue circle containing the number 3 next to it.

4 Click **Save** to apply your changes. Wait until the device restarts automatically.

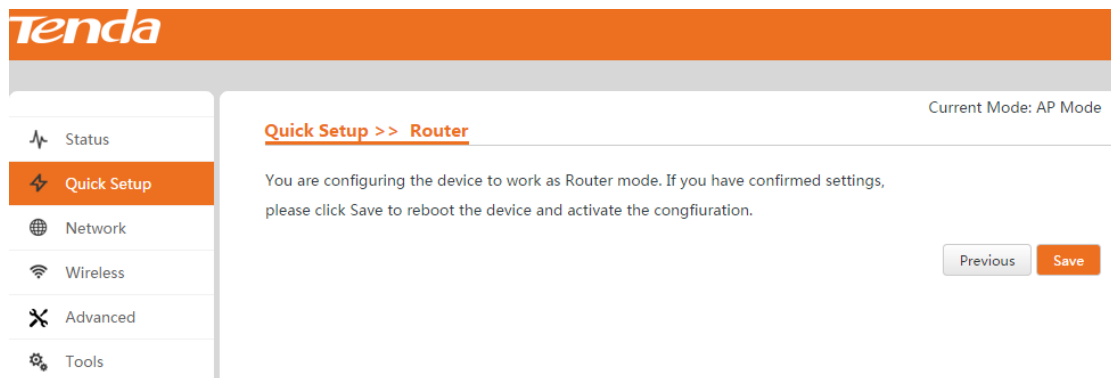

 **Tip**

After finishing operating mode settings mentioned above, please verify that devices connecting to the AP are set to **Obtain an IP address automatically** for Internet access.

# 3 Advanced Settings

## Status

To view system info, wireless info and statistics like throughput, clients info, port info, ARP table, etc., click **Status** to enter page below:

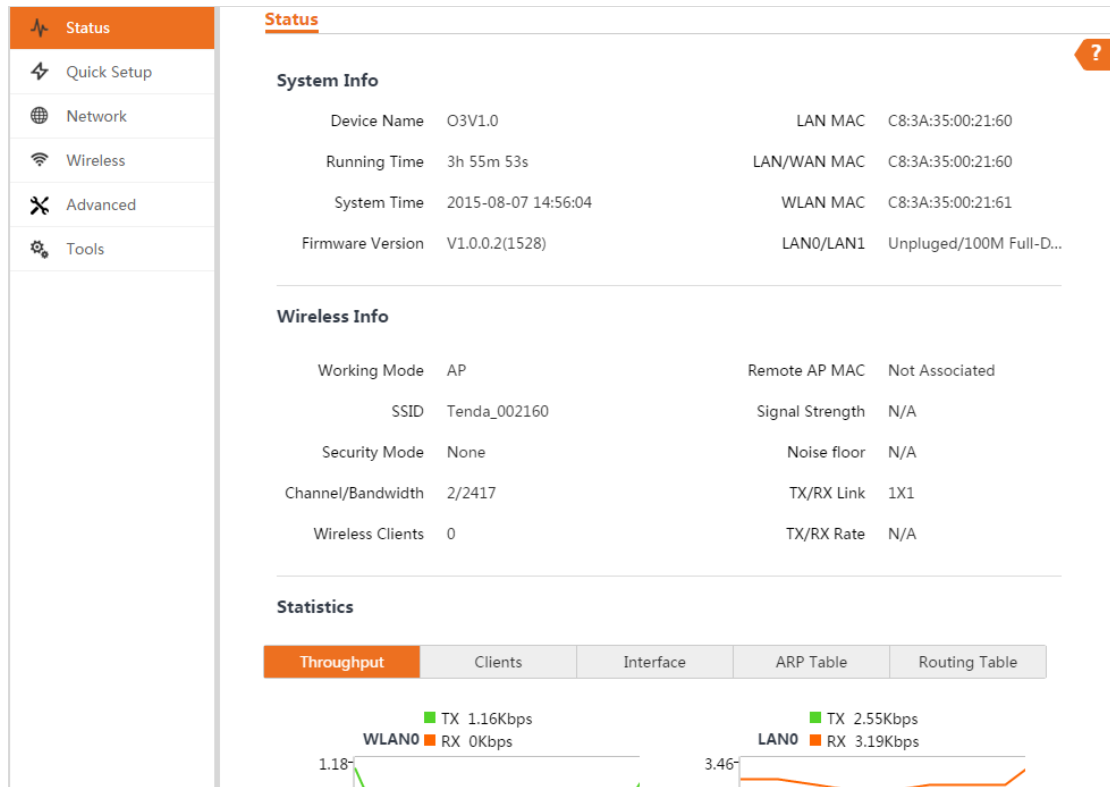

### System Info

- ◆ **Device Name** --- Display the remarks or identifier of the device.
- ◆ **Running Time** --- This is the total time the device has been running since the latest reboot.
- ◆ **System Time** --- Display the current system date and time. The date and time are displayed in YEAR-MONTH-DAY HOURS: MINUTES: SECONDS format.
- ◆ **Firmware Version** --- Display the device's current firmware version.
- ◆ **LAN MAC** --- Display the MAC address of the device as seen on the LAN interface.
- ◆ **LAN/WAN MAC** --- Display the MAC address of the device which can be seen on the WAN interface. This is the device's MAC address which can be seen over the Internet.
- ◆ **WLAN MAC** --- Display the wireless MAC address of the device.
- ◆ **LAN0/LAN1** --- Indicate the current status of the WAN and LAN Ethernet port connections.

This can indicate whether there's an active Ethernet connection on the corresponding port.

### Wireless Info

- ◆ **Working Mode** --- Display the operating mode of the device.
- ◆ **SSID** --- Display the WiFi name (SSID).
- ◆ **Security Mode** --- Display the wireless security method being used on the device.
- ◆ **Channel/Bandwidth** --- Display the channel number and corresponding operating frequency.
- ◆ **Wireless client** --- Indicate the number of connected wireless clients.
- ◆ **Remote AP MAC** --- In AP/Router mode, it displays as **Not Associated**. In Station/Universal Repeater/WISP/P2MP/Repeater mode, it displays the MAC address of the remote AP the device is associated with.
- ◆ **Signal Strength** --- Display the received wireless signal level.
- ◆ **Noise floor** --- Display the current value (in dBm) of the environmental noise the receiver hears on the operating frequency.
- ◆ **TX/RX Link** --- Display the number of independent spatial data flow the device is transmitting (TX) and receiving (RX).
- ◆ **TX/RX Rate** --- (Available in Station mode only.) Display the current 802.11 data transmission (TX) and data reception (RX) rates.

### Statistics

- ◆ **Throughput** --- Display the current data traffic on the LAN and WLAN. The chart scale and throughput dimension change dynamically depending on the mean throughput value. The statistics are updated automatically.
- ◆ **Clients** --- (Available in AP and Router mode) Display clients that are connected to the device.
- ◆ **AP Information** --- (Available in Station/WISP/Universal Repeater/P2MP/Repeater mode.) Display the connection statistics of the AP associated with the device.
- ◆ **Interface** --- Display MAC address, IP address, and traffic information of the device's interfaces.
- ◆ **ARP Table** --- List all the entries of the Address Resolution Protocol (ARP) table currently recorded on the device.
- ◆ **Routing Table** --- Display all the entries in the system's routing table.

## Quick Setup

This section mainly walks you through operating modes of the AP. Click **Quick Setup** to enter page below and you can select the proper operating mode in terms of your network environment. For specific configuration steps and application scenarios of different operating modes, see [Step 4: Quick Setup the AP](#).

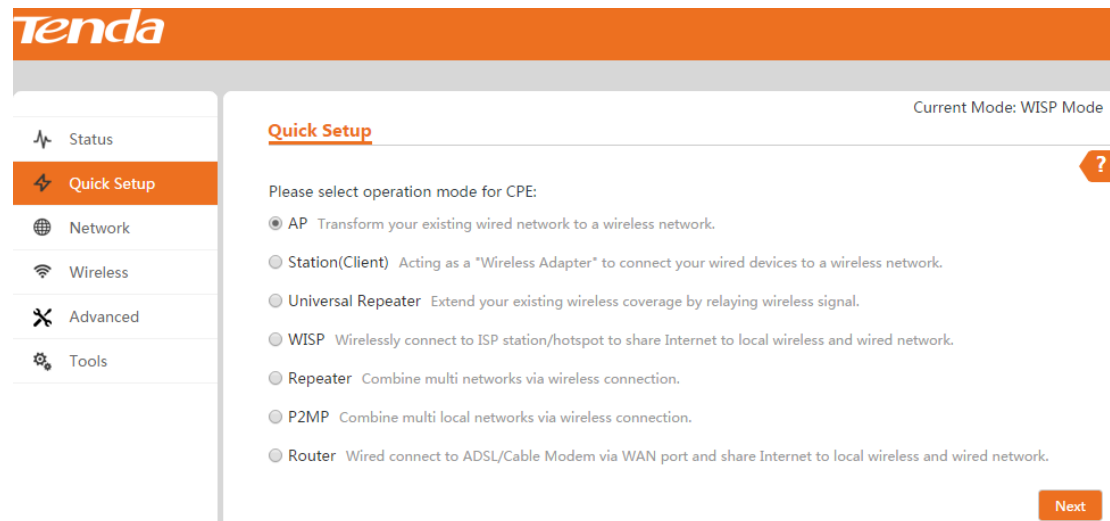

## Network

### How to Change the LAN IP Address

You can choose whether the AP gets its IP address manually (static IP) or automatically (DHCP).

Click **Network > LAN Setup** to enter page below:



The screenshot shows the Tenda LAN Setup interface. The sidebar on the left contains the following menu items: Status, Quick Setup, Network, LAN Setup (highlighted), DHCP Server, DHCP Client, Wireless, Advanced, and Tools. The main content area is titled 'LAN Setup' and includes a 'Current Mode: AP Mode' indicator. The configuration fields are as follows:

|                      |                   |
|----------------------|-------------------|
| MAC Address          | C8:3A:35:00:21:60 |
| Address Type         | Static IP         |
| IP Address           | 192.168.2.1       |
| Subnet Mask          | 255.255.255.0     |
| Default Gateway      | 192.168.2.254     |
| Preferred DNS Server | 192.168.2.254     |
| Alternate DNS Server |                   |

At the bottom right, there are 'Save' and 'Cancel' buttons.

To set your AP's IP address in **Static IP** mode:

- 1 **Address Type:** Select **Static IP**.
- 2 **IP Address:** Enter a unique IP address that will be used to login to this AP's web UI.
- 3 **Subnet Mask:** Enter the subnet mask of your network.
- 4 **Default Gateway:** Enter the IP address of the default gateway for your network.
- 5 **Preferred DNS Server:** Specify the IP address of the preferred DNS (Domain Name System) server.
- 6 **Alternate DNS Server:** Specify the IP address of the alternate DNS server. This entry is optional and used only if the primary DNS server is not responding.
- 7 Click **Save** to apply your changes.

**Note:**

In static IP address mode, once you've changed your LAN IP address, you need to use the new IP address to login to its web UI.

The screenshot shows the Tenda web interface for LAN Setup in AP Mode. The sidebar on the left contains navigation links: Status, Quick Setup, Network, LAN Setup (highlighted), DHCP Server, DHCP Client, Wireless, Advanced, and Tools. The main content area is titled 'LAN Setup' and displays the following configuration fields:

- MAC Address: C8:3A:35:00:21:60
- Address Type: DHCP (selected in a dropdown menu)
- IP Address: 192.168.2.1
- Subnet Mask: 255.255.255.0
- Default Gateway: 192.168.2.254
- Preferred DNS Server: 192.168.2.254
- Alternate DNS Server: (empty field)

At the bottom right of the form, there are 'Save' and 'Cancel' buttons. A 'Current Mode: AP Mode' indicator is visible in the top right corner of the main content area.

To set your AP's IP address in **DHCP** mode:

- 1 **Address Type:** Select **DHCP**.
- 2 Click **Save** to apply your changes.

**! Note:**

In DHCP mode, your LAN IP address is assigned by the DHCP server of your uplink device. Thus, to know your LAN IP address, you need to check it on the DHCP client list of the uplink device.

## How to Configure DHCP Server Settings

If you enable DHCP server on the device, it will automatically configure the TCP/IP settings for all your LAN computers (including IP address, subnet mask, gateway and DNS etc.), eliminating the need of manual intervention. Just be sure to set all computers on your LAN to be DHCP clients by selecting **Obtain an IP Address Automatically** respectively on each PC. When turned on, these PCs will automatically load IP information from the DHCP server. By default, the DHCP server on this device is enabled, it will be disabled after you finished quick setup when choosing AP/Station/Universal Repeater/Repeater/P2MP mode. Click **Network > DHCP Server** to enter page below:

- ◆ **DHCP Server** --- Check/Uncheck it to enable/disable the DHCP server.
- ◆ **Start IP** --- The start IP address that the DHCP server has automatically assigned.
- ◆ **End IP** --- The end IP address that the DHCP server has automatically assigned.
- ◆ **Subnet Mask** --- Define the device IP type for the chosen IP address range.
- ◆ **Default Gateway** --- Typically, this is the IP address of the host router, which provides the access to the Internet.
- ◆ **Primary DNS Server** --- Primary DNS server address.
- ◆ **Alternate DNS Server** --- Alternate DNS server address.
- ◆ **Lease Time** --- How long the IP address can be used by the client device.

## How to View DHCP Client Info

To view DHCP clients information, click **Network > DHCP Client** to enter page below:

| ID | IP Address    | MAC Address       | Lease Time  |
|----|---------------|-------------------|-------------|
| 1  | 192.168.2.141 | a8:a6:68:14:8c:15 | 22h 51m 32s |

## How to Clone MAC Address

In general, if you cannot access the Internet via your connected computer or smart-phone, meanwhile you find you can only access the Internet via a specified computer directly without a router, you can try cloning the MAC address on the MAC Clone page. It is especially useful if your ISP only assigns one valid IP address and it is associated to a specific MAC address. This is usually used by cable operators or some WISPs. **Note that this function is only available in Router mode.**

Click **Network > MAC Clone** to enter page below.

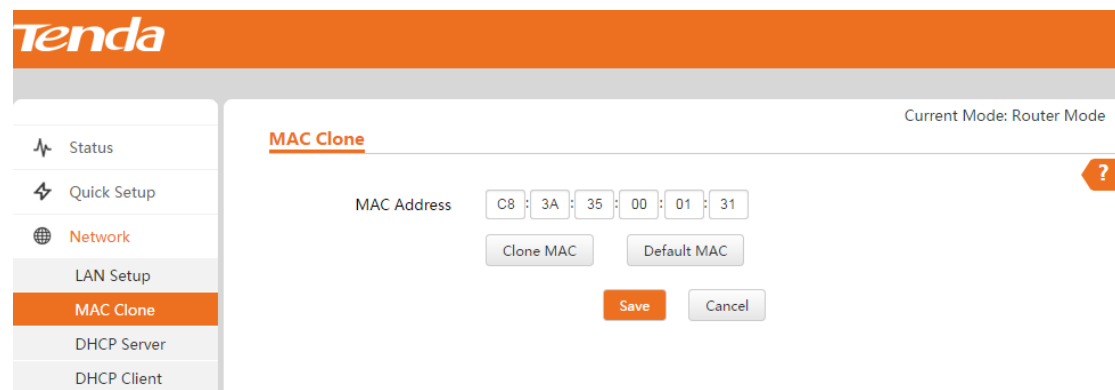

◆ If the specified computer connected to your device via an Ethernet cable, and you configure the router on the specified computer, follow the steps below:

① Click **Clone MAC** and the specified computer's MAC address will be entered in the MAC Address field.

② Click **Save**.

◆ If the computer connected to your device is not the specified computer, follow the steps below:

① Enter the MAC address of the specified computer in the MAC Address field.

② Click **Save**.

### Other Options may help:

**Default MAC:** Click it to restore the current MAC address to factory default MAC of the Router.

**Clone MAC:** Click it to copy the MAC address of the connected computer to the MAC Address field.

## Wireless

### How to Configure Basic Wireless Settings

To configure basic wireless settings, like SSID (WiFi name), network mode, TX power, etc., click

**Wireless > Basic** to enter page below:

The screenshot shows the Tenda wireless configuration interface. The sidebar on the left contains the following menu items: Status, Quick Setup, Network, Wireless, Basic (highlighted), Advanced, Access Control, Advanced, and Tools. The main content area is titled 'Basic' and displays the following settings:

- WiFi:  Enable  Disable
- Country: India (dropdown)
- SSID: Tenda\_002160 (text input)
- Broadcast SSID:  Enable  Disable
- Network Mode: 11b/g/n (dropdown)
- Security Mode: None (dropdown)
- Channel: Auto (dropdown)
- TX Power: 8dBm to 29dBm (slider)
- Bandwidth:  20  40  Auto
- Extension Channel: Auto (dropdown)
- AP Isolation:  Enable  Disable
- TX Rate: auto (dropdown)

At the bottom of the settings area, there are 'Save' and 'Cancel' buttons.

- ◆ **WiFi** --- Check the **Enable** box to enable the WiFi of your SSID or check the **Disable** box to disable the WiFi of your SSID.
- ◆ **Country** --- Select the country for your WiFi.
- ◆ **SSID** --- Customize the SSID as you like.
- ◆ **Broadcast SSID** --- When it is enabled, wireless clients are able to scan the SSID; when it is disabled, wireless clients are unable to scan the SSID. At this time, if you want to connect to it wirelessly, you have to type in the SSID and select the encryption mode manually.
- ◆ **Network Mode** --- Select a proper network mode: 11 b/g/n mixed, 11 b/g mixed, 11g or 11b.
- ◆ **Security Mode** --- Select WEP, WPA-PSK, WPA2-PSK, WPA-PSK&WPA2-PSK, WPA, WPA2.

(1) **WEP**: Compliant with the full IEEE 802.11 standard.

**Authentication Type:** Open or Shared. Enter a WEP key that is either 5 or 13 ASCII characters or 10 or 26 Hex characters when your authentication type is Open and Shared.

**Default Key:** Specify a WEP key from the preset keys for current use. For example, if you select Key 2, wireless clients must join your wireless network using this Key 2.

**WEP Keys:** ASCII and Hex are provided for you to configure. When you configure ASCII, you can choose 5 or 13 ASCII codes (only “0~9, a~z, A~Z, @, \*, -, \_” can be allowed). When you configure Hex, you can choose 10 or 26 hexadecimal numbers. One English letter or an Arabic numeral takes up one ASCII code.

(2) **WPA / WPA2 – PSK:** A mode based on WPA / WPA2 - PSK.

You can enable personal (PSK) or mixed mode, but you must make sure that the wireless client also supports the selected encryption method.

**Encryption Type:** Select AES, TKIP and TKIP & AES.

**Key:** Enter a security key that is either 8 - 63 ASCII characters or 8 - 64 Hex characters.

**Key Update Interval:** You can configure security key's update interval here within the range from 60 to 99999 seconds. If set to 0, the key will not be updated.

(3) **WPA/WPA2:** A mode based on Radius server authentication.

**Radius Server IP:** Display the Radius server's IP address.

**Radius Port:** Authentication port for Radius server. The default is 1812.

**Encryption Type:** Select AES, TKIP and TKIP&AES.

**Key:** Enter a key that is 1-64 ASCII characters.

**Key Update Interval:** You can configure security key's update interval here within the range from 60 to 99999 seconds. If set to 0, the key will not be updated.

◆ **Channel ---** For an optimal wireless performance, you may select the channel with least interference. It is advisable that you select 'Auto' to let the device detect and select the best possible channel for your wireless network to operate on.

◆ **TX Power ---** Define the maximum average transmitted output power (in dBm) of the device. To specify the output power, use the slider to adjust the output power. Transmitted power regulations differ in different countries.

◆ **Bandwidth ---** Display the bandwidth of the radio channel. You can use this option to control the bandwidth occupied by your link.

- ◆ **Extension Channel** --- This is used to ensure radio frequency for 802.11n devices on the network.
- ◆ **AP Isolation** --- When this function is enabled, wireless clients connected to the same SSID won't be able to communicate with each other, which can enhance wireless network security.
- ◆ **TX Rate** --- Define the data rate (in Mbps) at which the device should transmit wireless packets. You can fix a specific data rate between MCS 0 and MCS 7. Do not change the default setting "Auto" unless necessary. If you select 20 MHz Channel Width, the maximum data rate is MCS 7 (65 Mbps). If you select 40 MHz Channel Width, the maximum data rate is MCS 7(150 Mbps).

## How to Configure Advanced Wireless Settings

Click **Wireless > Advanced** to configure advanced wireless settings. If you are not familiar with these settings, keep the default settings unchanged.

The screenshot shows the Tenda wireless settings interface. The sidebar on the left contains the following menu items: Status, Quick Setup, Network, Wireless, Basic, **Advanced**, Access Control, Advanced, and Tools. The main content area is titled "Advanced" and displays the following settings:

- Transmission Range: 0.1 (Km Range: 0.1Km - 20Km, Eg.3.1)
- Beacon Interval: 100 (Range: 20 - 999ms)
- Fragment Threshold: 2346 (Range: 256 - 2346bytes)
- RTS Threshold: 2347 (Range: 1 - 2347bytes)
- DTIM Interval: 1 (Range: 1 - 255ms)
- Application Scenarios: Urban
- Signal Reception: Level 2
- WMM Capable:  Enable  Disable
- APSD Capable:  Enable  Disable
- Preamble:  Short  Long
- Sensitivity Threshold:  Disable  Enable
- Antenna Polarization:  Vertical  Horizontal

At the bottom of the settings area, there are "Save" and "Cancel" buttons.

- ◆ **Transmission Range** --- Specify the transmission range for your device between 0.1 km and 20 km.
- ◆ **Beacon Interval** --- This is a time interval between any two consecutive Beacon packets sent by an Access Point to synchronize a wireless network. Specify a valid value between 20 and 999. The default setting is 100.

- ◆ **Fragment Threshold** --- Specify a valid Fragment Threshold value between 256 and 2346. The default is 2346. Any wireless packet exceeding the preset value will be divided into several fragments before transmission.
- ◆ **RTS Threshold** --- Specify a valid value between 1 and 2347. The default is 2347. If a packet exceeds the preset value, RTS/CTS scheme will be used to reduce collisions. A smaller value is recommended if you have distant clients or interference on your network.
- ◆ **DTIM Interval** --- A DTIM (Delivery Traffic Indication Message) Interval is a countdown informing clients of the next window for listening to broadcast and multicast messages. When such packets arrive in the router's buffer, the router will send DTIM (delivery traffic indication message) and DTIM interval to alert clients of the receiving packets. Specify a valid value between 1 and 255. The default is 1.
- ◆ **Application Scenarios** --- Select the proper application environment for the device: urban or suburban.
- ◆ **Signal Reception**--- Adjust the signal receiving ability for your device.
- ◆ **WMM Capable** --- Enable Wi-Fi Multimedia feature to configure different minimum and maximum waiting times for the transmission of packets in each queue based on the requirements of the media being sent. Queues automatically provide minimum transmission delay for Voice, Video, multimedia, and mission critical applications, and rely on best-effort parameters for traditional IP data.
- ◆ **APSD Capable** --- APSD (Automatic Power Save Delivery) is disabled by default.
- ◆ **Preamble** --- Mainly used for preamble synchronization. It is advisable to keep the default value unchanged.
- ◆ **Sensitivity Threshold** --- Define the minimum client signal level accepted by the AP for the client to connect to. If the client signal level subsequently drops, the client remains connected to the AP.
- ◆ **Antenna Polarization** --- Adjust the angle of antennas for better wireless quality according to your environment.



## How to Filter Access to Your Network

Click **Wireless > Access Control** to enter page below. This page allows you to specify a list of devices to allow or disallow a connection to your wireless network via these devices' MAC addresses. To deactivate this feature, uncheck **Enable**; to activate it, check **Enable** and select **Forbid only** or **Permit only**.

The screenshot shows the Tenda web interface for the 'Access Control' settings. The left sidebar includes options like Status, Quick Setup, Network, Wireless, Basic, Advanced, Access Control (highlighted), Advanced, and Tools. The main content area shows the following configuration:

- SSID: Tenda\_002160
- MAC Filter:  Enable
- Filter Mode:  Forbid only  Permit only
- MAC Address input field: [ ] : [ ] : [ ] : [ ] : [ ] : [ ]
- Buttons: Add, Select from the online device
- Table with columns: ID, MAC Address, Status, Action
- Buttons: Save, Cancel

**For Example:** To only allow your computer at the MAC address of the A8:A6:68:14:8C:15 to join your wireless network:

- 1 Check the **Enable** box to enable the MAC Filter feature.
- 2 Select **Permit only** as the Filter Mode.
- 3 Enter the MAC address of the device you want to allow, say A8:A6:68:14:8C:15 and click **Add**. If the MAC address of the device you wish to control its access has already connected to this AP, you can directly click **Select from the online device** to add its MAC address.
- 4 Click **Save** to apply your changes.

**Tenda**

Current Mode: AP Mode

**Access Control**

SSID: Tenda\_002160

MAC Filter:  Enable

Filter Mode:  Forbid only  Permit only

MAC Address: A8 : A6 : 68 : 14 : 8C : 15

| ID | MAC Address       | Status                                     | Action                           |
|----|-------------------|--|----------------------------------|
| 1  | A8:A6:68:14:8C:15 | <input checked="" type="checkbox"/> Enable | <input type="button" value="X"/> |

## Advanced

### How to Set LAN Rate

To set the speed and duplex mode for LAN 0 or LAN/WAN port, click **Advanced** > **LAN Rate** to enter page below. It is advisable to keep the default setting **Auto** so that the device automatically negotiates transmission parameters, such as speed and duplex, with its remote device.

**Tenda**

**LAN Rate**

LAN0: Auto

LAN/WAN: Auto

- Auto
- 100M Full-Duplex
- 100M Half-Duplex
- 10M Full-Duplex
- 10M Half-Duplex

## How to Diagnose Your Network

Three ways are available here to diagnose your network. If there's something wrong with your network, select the proper one as you need. To deactivate this feature, select **Disable**.

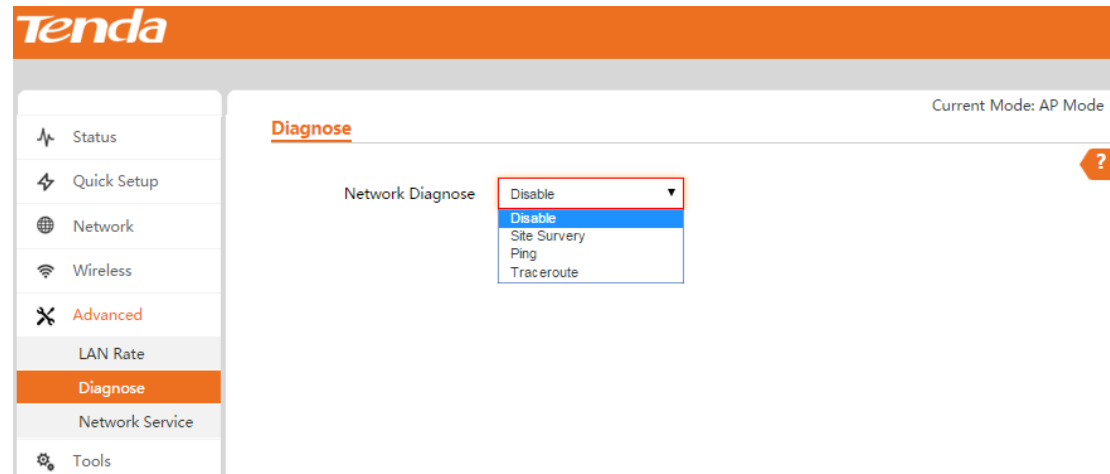

### Site Survey

To get an overview of your nearby wireless networks in range on all supported channels, click **Advanced > Diagnose** and then select **Site Survey**.

The Site Survey tool reports the SSID, MAC Address, Channel, Security Mode, Encryption Type, Signal Strength of each SSID in the surrounding environment.

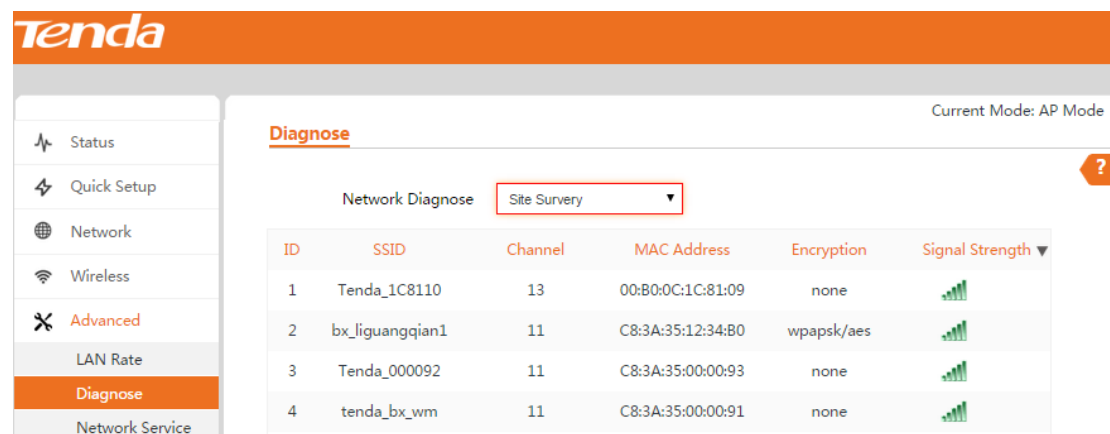

## Ping

Ping is a computer network administration utility used to test the reachability of a host on an Internet Protocol (IP) network and to measure the round-trip time for messages sent from the original host to a destination computer.

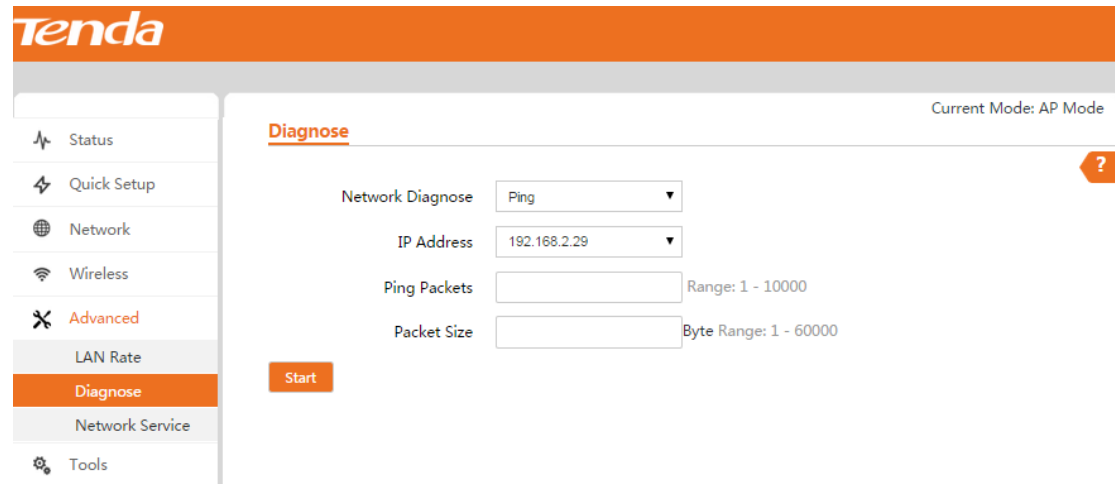

To implement Ping action, click **Tools > Diagnose** and finish settings as shown below:

- 1 Select **Ping** from the **Network Diagnose** drop-down menu.
- 2 Select the IP address you wish to diagnose or select **Manual** to enter the IP or domain name manually.
- 3 Set the number of Ping packets within the range from 1 to 10000.
- 4 Set the packet size within the range from 1 to 60000.
- 5 Click **Start** to Ping the network.

Then you can view the Ping info below.

The screenshot shows the Tenda web interface with the 'Diagnose' section selected in the left sidebar. The 'Network Diagnose' dropdown is set to 'Ping'. The IP Address is 192.168.2.29, Ping Packets is 2, and Packet Size is 4. A 'Start' button is visible. Below the settings, a table displays the ping results:

| Device IP    | Time    | TTL |
|--------------|---------|-----|
| 192.168.2.29 | 1.063ms | 64  |
| 192.168.2.29 | 0.947ms | 64  |

Summary statistics: 2 of 2 packets received, 0.00% loss. Min 0.947ms, Avg 1.005ms, MAX 1.063ms.

## Traceroute

Traceroute is a computer network diagnostic tool for displaying the route (path) and measuring whether network connection is available or not. When malfunctions occur to the network, you can locate trouble spot of the network with this traceroute test.

The screenshot shows the Tenda web interface with the 'Diagnose' section selected in the left sidebar. The 'Network Diagnose' dropdown is set to 'Traceroute'. The 'Destination IP/Domain Name' field is empty. A 'Start' button is visible.

To implement Traceroute action, click **Tools > Diagnose** and finish settings as shown below:

- 1 Select **Traceroute** from the **Network Diagnose** drop-down menu.
- 2 Enter the destination IP or domain name of the destination host.
- 3 Click **Start** to traceroute the network.

Then you can view the traceroute info below.

The screenshot shows the Tenda web interface in 'AP Mode'. The left sidebar contains navigation options: Status, Quick Setup, Network, Wireless, Advanced, LAN Rate, Diagnose (highlighted), Network Service, and Tools. The main content area is titled 'Diagnose' and includes a 'Network Diagnose' dropdown menu set to 'Traceroute', a 'Destination IP/Domain Name' input field containing '192.168.2.29', and a 'Start' button. Below this, a 'Result' table displays the following data:

| ID | IP Address   | Time                |
|----|--------------|---------------------|
| 1  | 192.168.2.29 | 1.403 ms * 0.969 ms |

## How to Reboot Your AP Regularly

When some settings you have configured cannot be activated or your device is functioning improperly, you can reboot your device. Once this function is enabled, please make sure that your device is synchronized with the Internet time server.



### Tip

1. To activate this feature, verify that you have synchronized the device's system time with the Internet or your PC.
2. To reboot your AP manually, see [How to Reboot your AP Manually](#).

To reboot your device regularly and automatically, follow steps below:

- 1 Click **Advanced > Network Service** and locate the Regular Reboot section.
- 2 Check the **Enable** box of **Regular Reboot**.
- 3 Set the specific time to regular reboot your device.
- 4 Set the date (from Monday to Sunday) to regular reboot your device.
- 5 Click **Save** at the bottom of this page to apply your changes.

### Network Service

Regular Reboot  Enable

Time

Date  Mon.  Tue.  Wed.  Thu.  
 Fri.  Sat.  Sun.  Everyday

## How to Log in to Web UI in a More Secure Way

This function enables you to log in to its web UI in a more secure way.

### Configuration Steps:

- 1 Click **Advanced > Network Service** and locate the HTTP web service feature.
- 2 Check the **Enable** box to enable HTTP web service feature.
- 3 Enter the HTTP web service port. By default, it is port 80.
- 4 Click **Save** at the bottom of this page to apply your changes.

Web Service  Enable

WEB Service Port

- 5 Then you need to enter “**http://login IP address: port No.**” in the address bar to log in to its web UI. Here we enter “**http://192.168.2.1:80**” in the address bar.

## How to Configure the Idle Timeout

You are automatically logged out of the web UI after a period of inactivity. You can set the length of the inactive period. To change the page idle timeout, click **Advanced > Network Service**, locate the Page Timeout field, set the page timeout you wish to (Range: 1~60 minutes) and click **Save**.

Page Timeout  Min Range: 1-60 Minutes

## How to Configure SNMP Settings

The Simple Network Management Protocol (SNMP) is widely used in local area networks (LANs) for collecting information, managing, and monitoring network devices, such as servers, printers, hubs, switches, and routers. Specialized software in each SNMP capable device, known as an Agent, continuously monitors the status of the device and reports the results to the SNMP Manager software, which can then act on the report.

|   |                                 |
|---|---------------------------------|
| SNMP  | <input type="checkbox"/> Enable |
| Device Name   | O3V1.0                          |
| Read Community  | public                          |
| Read/Write Community  | private                         |
| Location  | ShenZhen                        |
| <input type="button" value="Save"/> <input type="button" value="Cancel"/> |                                 |

- ◆ **SNMP** --- Disable/Enable the SNMP function.
- ◆ **Device Name** --- Device name of the device.
- ◆ **Read Community** --- Indicate the community string for read access to permit reading this AP's SNMP information. The default is Public.
- ◆ **Read/Write Community** --- Indicate the community string for write/read access to permit reading and re-writing this AP's SNMP information. The default is Private.
- ◆ **Location** --- Specify the physical location of the device.

## How to Manage Your Device via Telnet

Telnet is another way to manage your device via cmd commands. Click **Advanced > Network Service** and slide to the bottom of the current page to locate the Telnet section.



Telnet  Enable

UPNP  Enable

Save Cancel

## How to Enable the UPNP Settings

When UPnP is enabled on your device, a network device possessing a specific purpose, such as a printer, can be identified and used automatically by another computer or device on your network.

If the UPNP protocol is disabled, other devices behind this device may have difficulty communicating their identification or purpose. Access your device to turn on UPNP. Click **Advanced** > **Network Service** and slide to the bottom of this page to locate the UPNP section.

UPNP  Enable

Save Cancel

## How to Prioritize Your Network Bandwidth Usage

The section helps you to improve network performance by specifying the downstream/upstream speed for computers. **Note that this function is only available in WISP and Router mode.** Click

**Advanced** > **Traffic Control** to enter page below:

**Tenda**

Current Mode: WISP Mode

**Traffic Control**

| ID  | Remarks | IP Range | Upstream | Downstream | Action |
|-----|---------|----------|----------|------------|--------|
| Add |         |          |          |            |        |

[Status](#) | 
 [Quick Setup](#) | 
 [Network](#) | 
 [Wireless](#) | 
 [Advanced](#) | 
 [LAN Rate](#) | 
 [Diagnose](#) | 
 [Traffic Control](#) | 
 [Port Forwarding](#) | 
 [MAC Filter](#) | 
 [Network Service](#)

For a better and reasonable network bandwidth experience, here you can configure the bandwidth to limit the speed of users with different IPs. Click **Add** to enter page below:

**Traffic Control**
✕

---

Remarks

Start IP

End IP

Max Upstream  KB/s ▼

Max Downstream  KB/s ▼

Save

- ◆ **Remarks** --- Description of the rule.
- ◆ **Start/End IP** --- If you want to specify a rule for several devices which get IPs within an IP range, you need to enter the start IP and end IP to these two fields respectively.
- ◆ **Max Upstream/Downstream** --- Specify an upstream/downstream bandwidth range limit on specified PC(s). Note that maximum upstream/downstream bandwidth should not exceed your router's WAN bandwidth limit. (Consult your ISP if you are not clear.)

## How to Visit the Intranet Resource from the Internet by Configuring Port Forwarding Settings

Port forwarding is useful for web servers, ftp servers, e-mail servers, gaming, and other specialized Internet applications. When you enable Port Forwarding, the communication requests from the Internet to your router's WAN port will be forwarded to the specified IP address.

**Note that this function is only available in WISP and Router mode.**

### Application Example:

Your PC (PC1: 192.168.0.101) connects to the device and runs an FTP server on port number 21.

Your friend (PC2: 192.36.244.96) from the Internet wants to access the FTP server on your PC.

**Tip**

1. Make sure your WAN IP address (Internet IP address) is a public IP address. Private IP addresses are not routed on the Internet.
2. Make sure that the service port number you entered on the router and the service port number you configured on the PC are identical.
3. To ensure that your server computer always has the same IP address, assign a static IP address to your PC.
4. Operating System built-in firewall and some anti-virus programs may block other PCs from accessing resources on your PC. So it is advisable to disable them before using this feature.

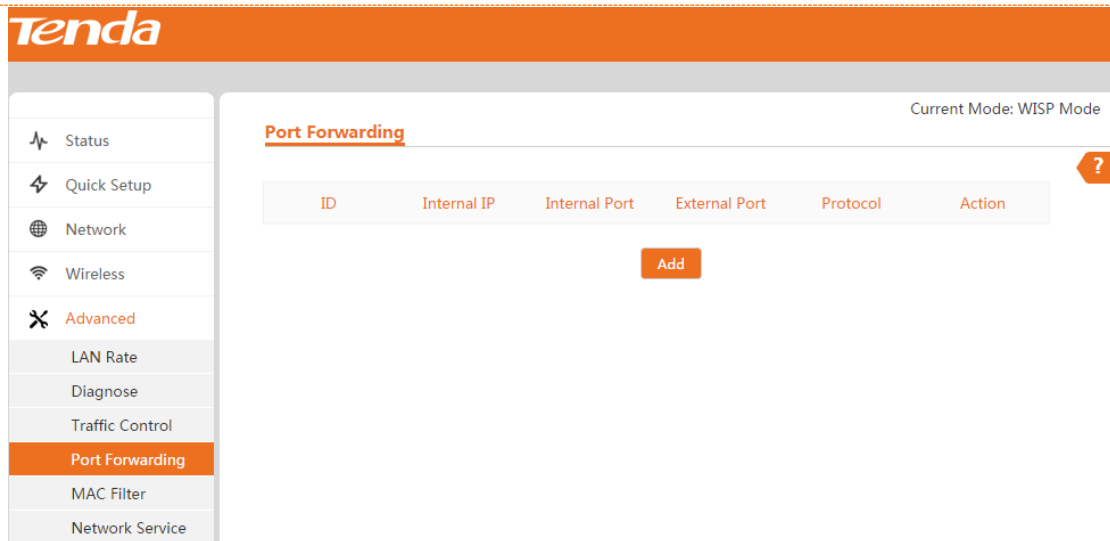

- 1 Click **Advanced > Port Forwarding** to enter the page as shown above and click **Add** to enter page below.

**Port Forwarding**
✕

---

Internal IP

Internal Port

External Port

Protocol TCP/UDP ▼

Public Service None ▼

Save

- 2 **Internal IP:** Specify the internal host's IP address. In this example, enter 192.168.0.101.
- 3 **Internal/External Port:** Specify the internal port and external port. Contact the corresponding service provider or google it if you don't know the port number of the service to use.
- 4 **Protocol:** Specify the protocol required for the service utilizing the port(s). Select TCP/UDP if you are not sure.
- 5 **Public Service:** Some common public service ports are available here. If the service port you want to use is included in its drop-down list, select the corresponding one. If not, select None.
- 6 Click **Save** to apply your changes.

Now, your friends only needs to enter <ftp://xxx.xxx.xxx.xxx:21> in their browsers to access your FTP server. xxx.xxx.xxx.xxx is the router's WAN IP address.

 **Note:**

If you use the port number 80 here, you must set the port number for remote Web access (Click **Advanced > Network Service** to locate the Remote Web Access section) to any port number excluding 80 to avoid conflicts. Otherwise the port forwarding feature may not be effective.

## How to Filter Internet Access via MAC Addresses

This section allows you to set that specific clients can or cannot access the Internet via devices' MAC Addresses. **Note that this function is only available in WISP and Router mode.**

**Forbid Only:** Specify a list of devices to Forbid access to the Internet. All other devices not listed as Forbidden will be permitted.

**Permit Only:** Specify a list of devices to Permit access to the Internet. All other devices not listed as Permitted will be forbidden.

**Example:** To allow the computer (MAC address --- 00:E4:A5:44:35:69) to access the Internet from 13:00~18:00 on Sunday to Saturday, do as steps below.

1 Click **Advanced > MAC Filter** to enter page below and then click **Add**.

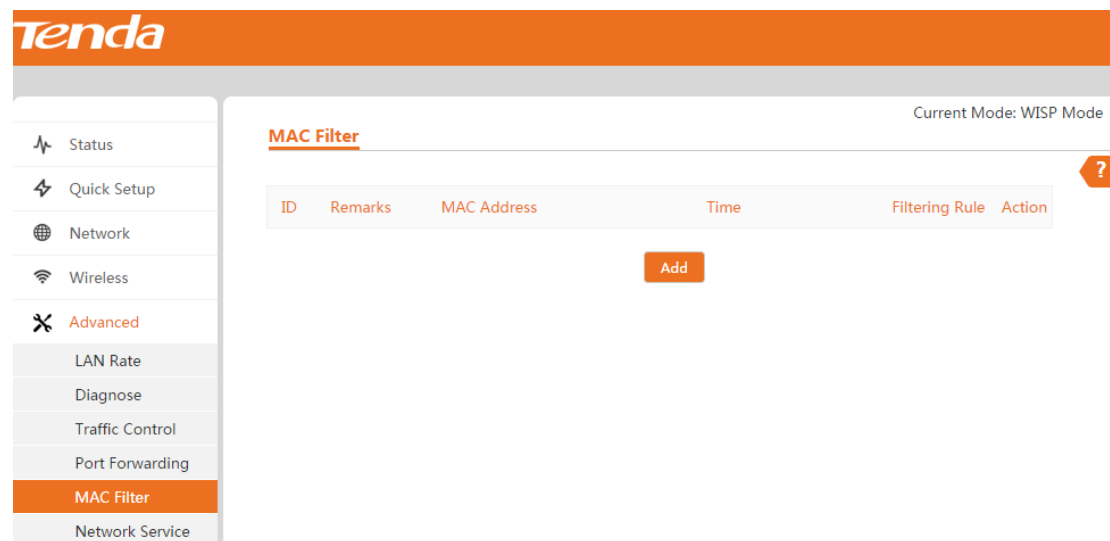

**MAC Filter** [X]

Filtering Rule: Permit only

Remarks: [Empty]

MAC Address: 00:E4:A5:44:35:69

Time: 13 : 00 ~ 18 : 00

Day:  Mon.  Tue.  Wed.  Thu.  Fri.  Sat.  Sun.  Everyday

Save

2 **Filtering Rule:** Select **Permit only** from the drop-down list.

- 3 **Remarks:** Enter a descriptive name for the rule, or leave it blank.
- 4 **MAC Address:** Input the MAC address of the device you want to permit, here 00:E4:A5:44:35:69.
- 5 **Time, Day:** Select 13:00~18:00, Sat~Sun.
- 6 Click **Save** to apply your settings.

## How to Configure DDNS Settings

Dynamic DNS or DDNS is a term used for the updating in real time of Internet Domain Name System (DNS) name servers. We use a numeric IP address allocated by Internet Service Provider (ISP) to connect to Internet; the address may either be stable ("static"), or may change from one session on the Internet to the next ("dynamic"). However, a numeric address is inconvenient to remember; an address which changes unpredictably makes connection impossible. The DDNS provider allocates a static host name to the user; whenever the user is allocated a new IP address this is communicated to the DDNS provider by software running on a computer or network device at that address; the provider distributes the association between the host name and the address to the Internet's DNS servers so that they may resolve DNS queries. Thus, uninterrupted access to devices and services whose numeric IP address may change is maintained.

**Note that this function is only available in WISP and Router mode.**

Click **Advanced** > **Network Service** to locate the DDNS section.

Current Mode: Router Mode

---

**Network Service**?

DDNS  Enable

Service Provider  [Register](#)

User Name

Password

Domain Name

**Tip**

1. To use the DDNS feature, you need to have an account with one of the domain service providers in the drop-down menu first.
2. This device supports 4 DDNS service providers: 88ip.cn, 3322.org, dyndns and no-ip.com.

**Application Example:**

If your ISP gave you a dynamic (changing) public IP address, you want to access your device remotely but you cannot predict what your device's WAN IP address will be, and the address can change frequently. In this case, you can use a commercial Dynamic DNS service. It lets you register your domain to their IP address and forwards traffic directed at your domain to your frequently changing IP address.

Assume that you obtain the following account from your dyndns.org service provider:

*User Name: tenda*

*Password: 123456*

*Domain Name: tenda.dyndns.org.*

*And you want to use the PC at 218.88.93.33 to remotely access this router on port number 8080.*

**Configuration Steps:**

- 1 **DDNS:** Check the DDNS box to enable this function.
- 2 **Service Provider:** Select your DDNS service provider from the drop-down menu. Here in this example, select dyndns.org.
- 3 **User Name:** Enter the DDNS user name registered with your DDNS service provider. Here in this example, enter tenda.
- 4 **Password:** Enter the DDNS Password registered with your DDNS service provider. Here in this example, enter 123456.
- 5 **Domain Name:** Enter the DDNS domain name with your DDNS service provider. Here in this example, enter tenda.dyndns.org.
- 6 Click **Save** at the bottom of this page to save your settings.
- 7 Click **Advanced > Network Service** to locate the Remote Web Access section to enable the Remote WAN function, enter 218.88.93.33 in the IP Address field, and 8080 in the Port field , then click **Save** to save your settings.

|                   |                                      |
|-------------------|--------------------------------------|
| Remote Web Access | <input type="checkbox"/> Enable      |
| IP Address        | <input type="text" value="0.0.0.0"/> |
| Port              | <input type="text" value="8080"/>    |

Now you can access the device from the Internet by entering <http://tenda.dyndns.org:8080> in your browser.

## How to Manage the Device Remotely

The Remote Web Access function allows the device to be configured and managed remotely from the Internet via a web browser. Click **Advanced > Network Service** to locate the Remote Web Access section. **Note that this function is only available in WISP and Router mode.**



### Tip

1. For better security, customize a port number between 1024 and 65535 for the remote WAN interface. Do not use the number of any common service port (1-1024) in case of conflicts.
2. Make sure your WAN IP address (Internet IP address) is a public IP address. Private IP addresses are not routed on the Internet.
3. It is unsafe to make your device remotely accessible to all PCs on external network. For better security, we suggest that only enter the IP address of the PC for remote management.

**To access your device (WAN IP address: 102.33.66.88) at your home from the PC (218.88.93.33) at your office via the port number 8080:**

|                   |                                      |
|-------------------|--------------------------------------|
| Remote Web Access | <input type="checkbox"/> Enable      |
| IP Address        | <input type="text" value="0.0.0.0"/> |
| Port              | <input type="text" value="8080"/>    |

- 1 Check the **Enable** box to enable the Remote Web Access function.
- 2 IP Address: Specify the IP address for remote management (When it is set to 0.0.0.0, the device becomes remotely accessible to all the PCs on Internet or other external networks. It is not safe). In this example, enter 218.88.93.33.



3 Port: Specify the management port to be open to outside access. The default setting is 8080.

This can be changed.

4 Click **Save** to apply your changes.

Type <http://102.33.66.88:8080> into your browser's address or location field and you can access the device at your home remotely.

## Tools

### How to Configure System Time for Your Device

This section assists you in setting the device's current time; you can select to either set the time and date manually or obtain the GMT time from the Internet automatically. System time can be configured using the following 2 methods:

**Synchronized with the Internet:** If enabled, system automatically connects to NTP server on the Internet to synchronize the time.

**Manual:** Specify the time and date manually or click **Synchronized with local time** to automatically copy your current PC's time to the device.

#### To Sync with Internet time servers:

- 1 Click **Tools > Date & Time** to enter page below.
- 2 Select **Synchronized with the Internet**.
- 3 Select a time interval from the drop-down list.
- 4 Select your time zone.
- 5 Click **Save**.

**Tenda**

Current Mode: AP Mode

**Date & Time**

Time Setup  Synchronized with the Internet  Manual

Time Interval

Time Zone

### To set time and date manually:

- 1 Click **Tools > Date & Time** to enter page below.
- 2 Select **Manual**.
- 3 Specify the time and date manually or click **Synchronized with local time** to automatically copy your PC's time to the device.
- 4 Click **Save**.

**Tenda**

Current Mode: AP Mode

**Date & Time**

Time Setup  Synchronized with the Internet  Manual

Date & Time  Year  Month  Day  h  m  s

And then go to the **Status** page to make sure that the system time is correctly updated.

## How to Reboot your AP Manually

To reboot your device manually, click **Tools > Maintenance**, locate the Reboot Router section and click **Reboot**.

**Reboot Device**

All connections will disconnect during reboot.

## How to Reset Your AP

If the device or client connected to the device fails to access the Internet due to incorrect configurations and you cannot solve the problem, you can reset the device. Once you reset your AP, all your current settings will be lost and you need to reconfigure it.

To reset your AP, two methods are available:

### Method 1: Via Web UI

Click **Tools > Maintenance**, locate the Reset to Factory Settings and click **Reset**.

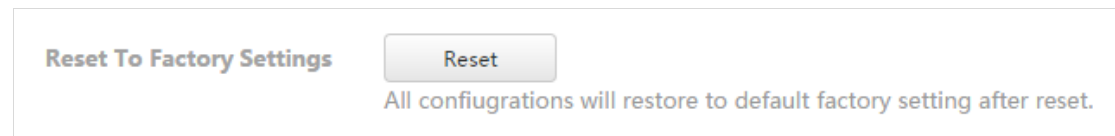

### Method 2: Via the hardware RST button

Pressing the **RST** button for over 7 seconds restores this device to its factory defaults.

#### Factory Default Settings:

- User Name: admin
- Password: admin
- IP Address: 192.168.2.1

## How to Upgrade Your AP

If your device is in normal operation, it is not advisable to upgrade your device. If you want to acquire the latest software version or better value-added functions for your device, you can access our official website [www.tendacn.com](http://www.tendacn.com) to download the latest software for upgrading.

To upgrade your AP:

- 1 Launch a web browser and go to <http://www.tendacn.com> to download the latest firmware.
- 2 Unzip the compressed upgrade file in the corresponding directory.
- 3 Click **Tools > Maintenance**, locate the Upgrade Firmware section and click **Upgrade**.

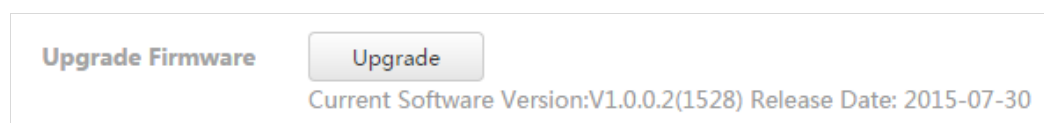

- 4 Click **Choose File** (in Google browser) to locate and select the upgrade file in the corresponding directory on your hard disk.

Upgrade
✕

---

Current Software Version
V1.0.0.2(1528)

Select a Firmware File

Choose File

No fi...osen

Upgrade

Note: While upgrading, please verify that your PC is connected to the device with an Ethernet cable and power is delivered on this device.

5 Click **Upgrade**.

**! Note:**

1. While upgrading, please verify that your PC is connected to the device with an Ethernet cable and power is delivered on this device. And the upgrading process will take several minutes, please be patient.
2. When the upgrading is completed, your device will be restored to factory default settings automatically and you need to reconfigure your device.

## How to Backup and Restore Your AP's Configurations

If you configure many settings on this device, which will make this device work in good status and suitable environment, it's suggested to backup settings for this device, which will be convenient for troubleshooting and saving time for next time's configuration. Click **Tools > Maintenance** and locate the Backup/Restore section.



Backup / Restore

Backup / Restore

Backup current settings or import saved settings to device

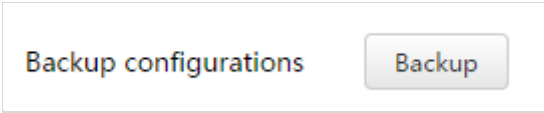

**To backup your configurations:**

- 1 Click **Backup / Restore**.
- 2 Click **Backup** on the pop-out window and follow on screen instructions to save your configurations in a directory on your hard disk.

To restore your configurations:

- 1 Click **Backup / Restore**.
- 2 Click **Choose File** (in Google browser) to load configuration files which you have stored on your hardware disk previously.
- 3 Click **Restore**.

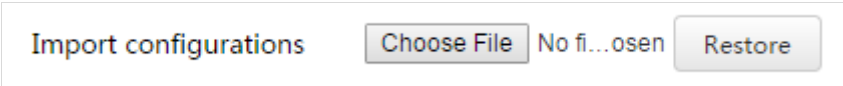
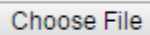
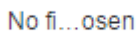
## How to Change Your Login Account

Click **Tools > Administrator** to enter screen below. Here you can change the user name and password for administrator and guest account. As an administrator, you can modify and view the settings. However, as for the guest account, you can only view the settings. We suggest that you change the administrator password to a more secure one.

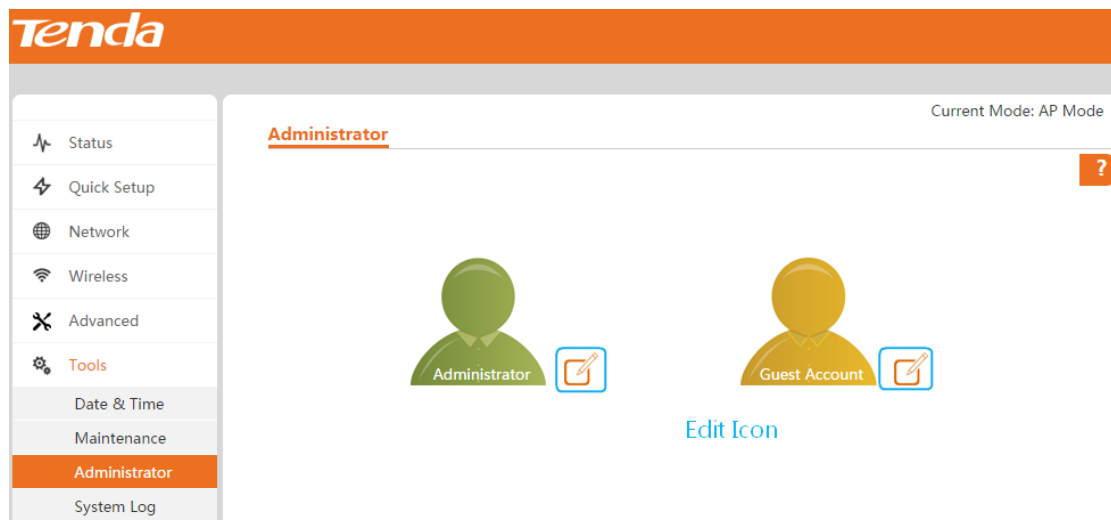

To change the login user name and password for the administrator, click the Administrator edit icon:

**Administrator** ✕

|                  |                                    |
|------------------|------------------------------------|
| Old User Name    | <input type="text" value="admin"/> |
| Old Password     | <input type="text"/>               |
| New User Name    | <input type="text"/>               |
| New Password     | <input type="text"/>               |
| Confirm Password | <input type="text"/>               |

To change the login user name and password for the guest, click the Guest Account edit icon:

**Guest Account** ✕

|                  |                                   |
|------------------|-----------------------------------|
| Old User Name    | <input type="text" value="user"/> |
| Old Password     | <input type="text"/>              |
| New User Name    | <input type="text"/>              |
| New Password     | <input type="text"/>              |
| Confirm Password | <input type="text"/>              |

## How to View the History of Your AP's Actions

Click **Tools > System Log** to enter page below. Here you can view the history of the device's actions. Three types of logs are supported on this device: All, System and WAN. You can select any one of them from the drop-down list. Click **Refresh** to update current log info or click **Clear** to clear all logs.

**Tenda**

Current Mode: AP Mode

**System Log**

Refresh Clear Log Type: ALL

| ID | Time                | Type   | Log                    |
|----|---------------------|--------|------------------------|
| 1  | 2011-05-01 00:00:01 | system | System Start Success   |
| 2  | 2011-05-01 00:00:06 | system | 2.4G Wifi UP           |
| 3  | 2014-01-01 00:00:00 | system | SNMP Stop              |
| 4  | 2014-01-01 00:00:06 | system | 2.4G Wifi UP           |
| 5  | 2015-08-07 11:06:01 | system | web 192.168.2.69 login |
| 6  | 2015-08-07 11:16:52 | system | web 192.168.2.69 login |
| 7  | 2015-08-07 11:18:02 | system | web 192.168.2.69 login |

# Appendix

## 1 Configure PC

### Windows 8

- 1 Right click the icon  on the bottom right corner of your desktop.



- 2 Click **Open Network and Sharing Center**.

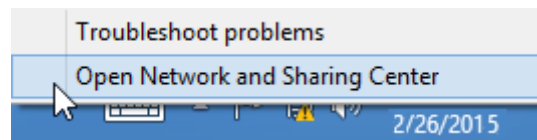

- 3 Click **Ethernet > Properties**.

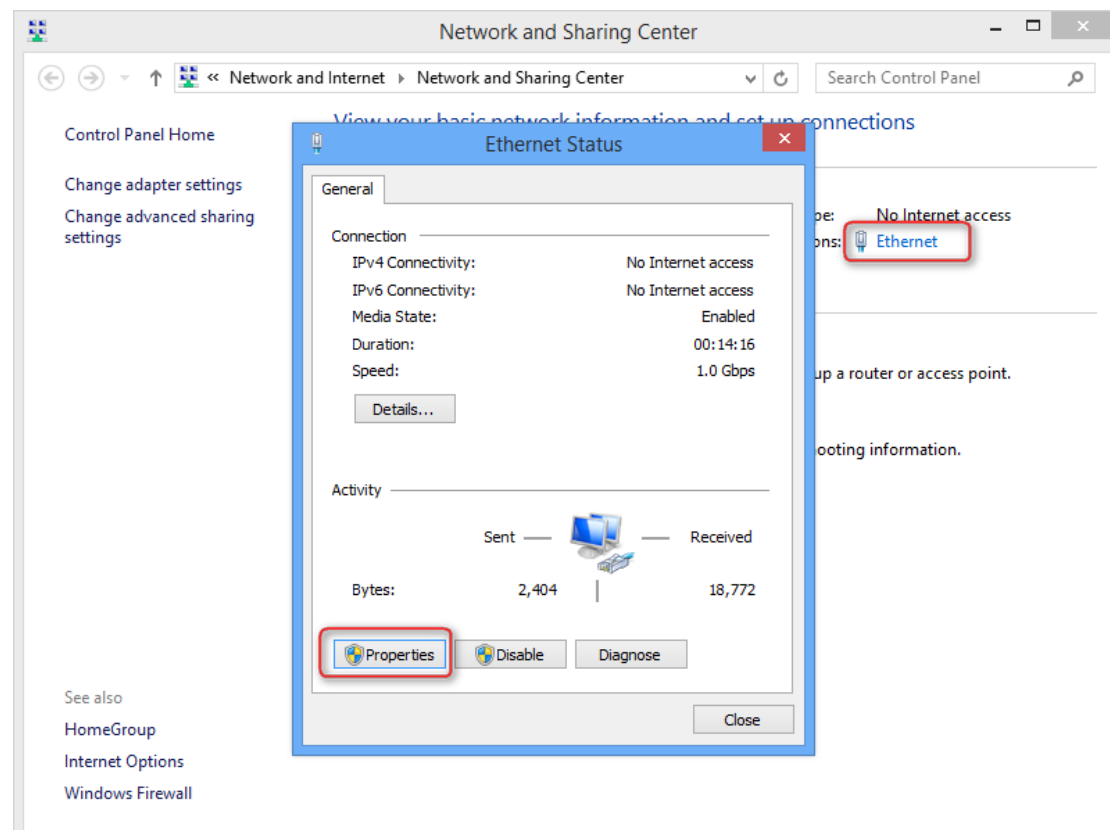

- 4 Find and double click **Internet Protocol Version 4(TCP/IPv4)**.



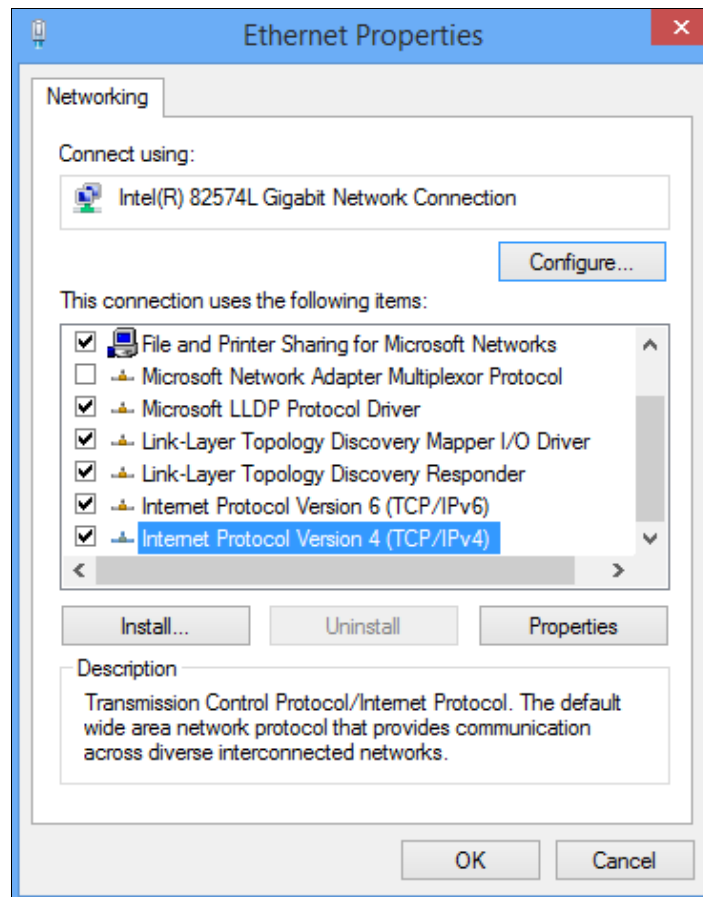

- 5 Select **Use the following IP address**, type in the IP address: **192.168.2.x** (2~253), Subnet mask: **255.255.255.0** and click **OK**.

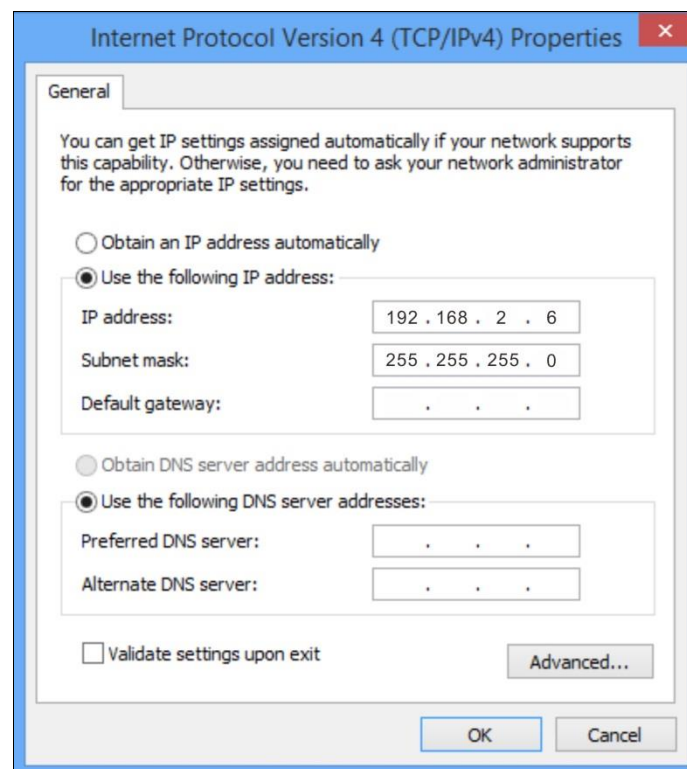



- 6 Click **OK** on the **Ethernet Properties** window.

## Windows 7

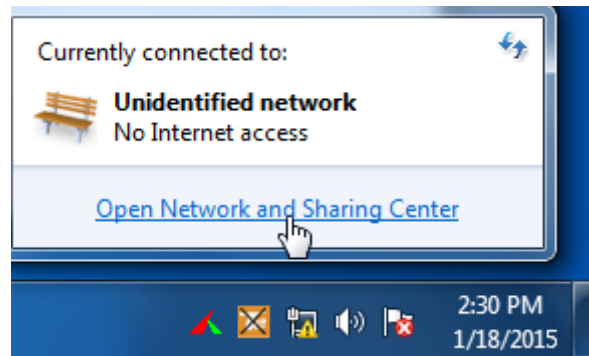
- 1 Click the icon  on the bottom right corner of your desktop.
- 2 Click **Open Network and Sharing Center**.



### Tip

If you cannot find the icon  on the bottom right corner of your desktop, follow steps below:  
Click **Start**  > **Control Panel** > **Network and Internet** > **Network and Sharing Center**.

- 3 Click **Local Area Connection** > **Properties**.

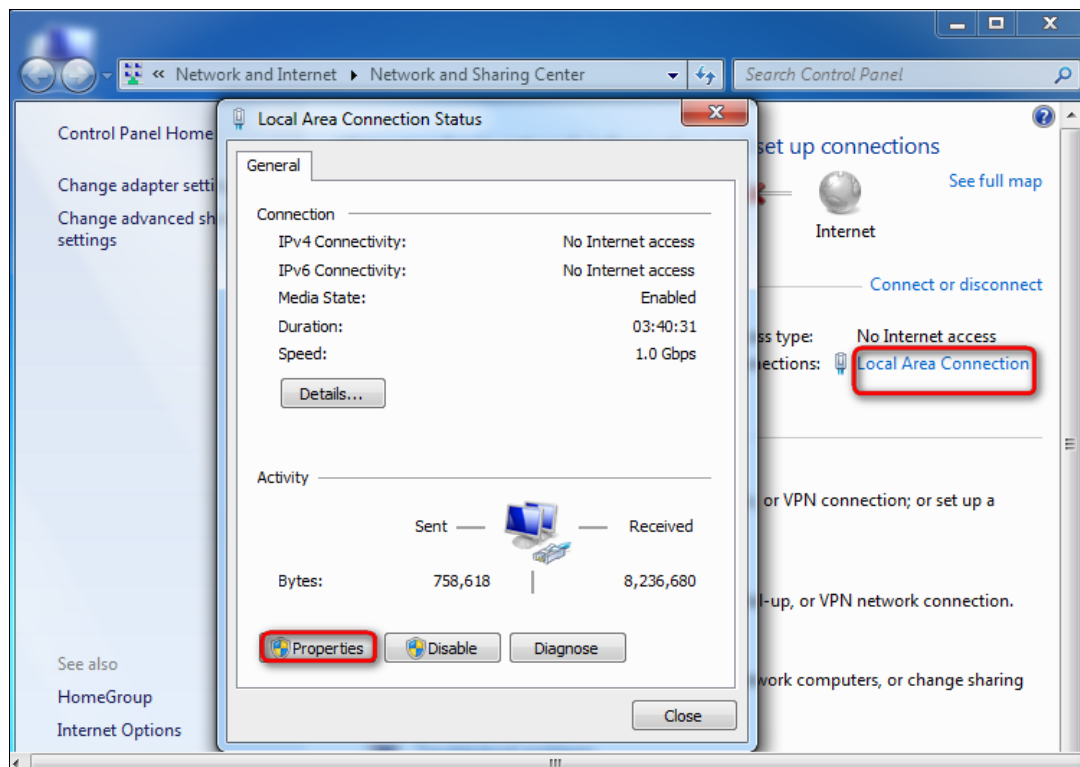

- 4 Find and double click **Internet Protocol Version 4(TCP/IPv4)**.

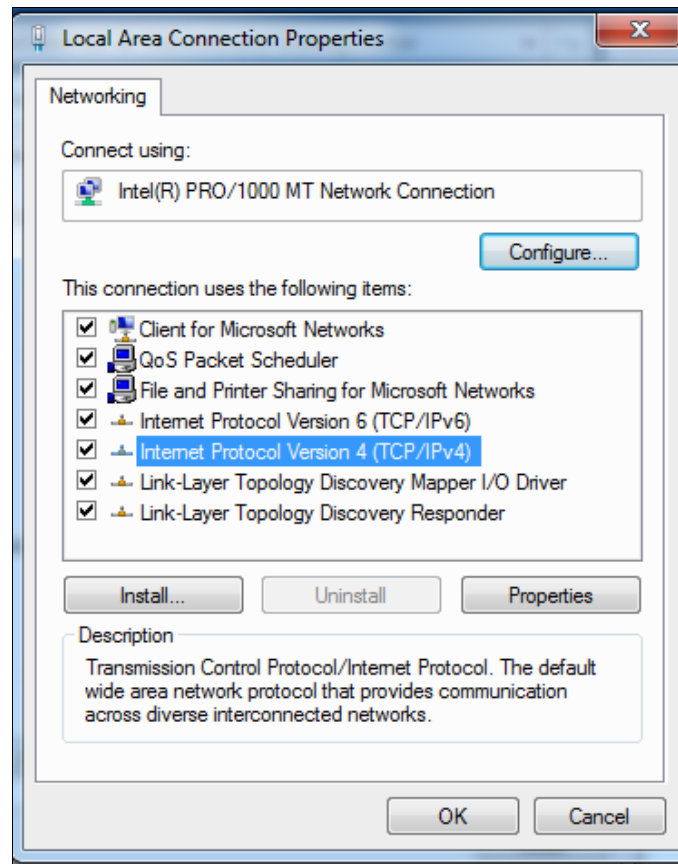

- 5 Select **Use the following IP address**, type in the IP address: **192.168.2.x** (2~253), Subnet mask: **255.255.255.0** and click **OK**.

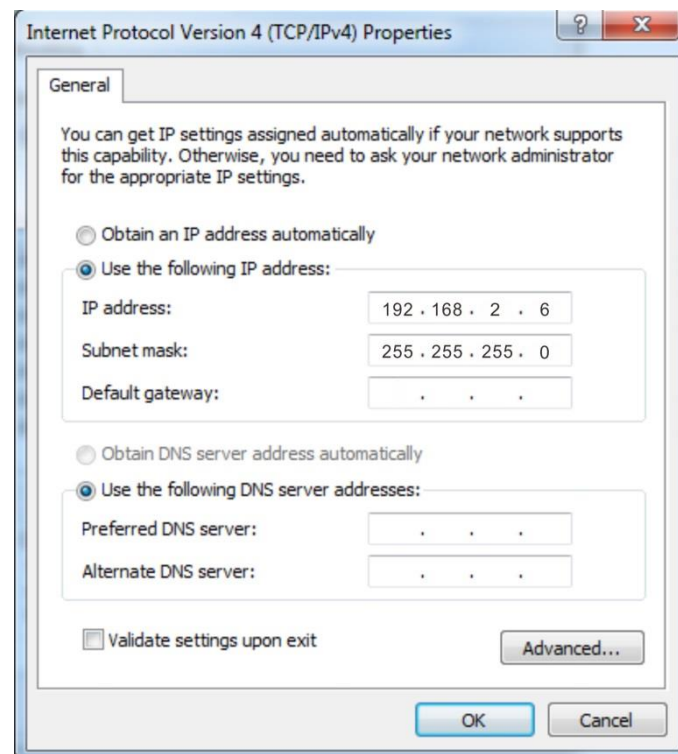

- 6 Click **OK** on the **Local Area Connection Properties** window.

## Windows XP

- 1 Right click **My Network Places** on your desktop and select **Properties**.



- 2 Right click **Local Area Connection** and select **Properties**.

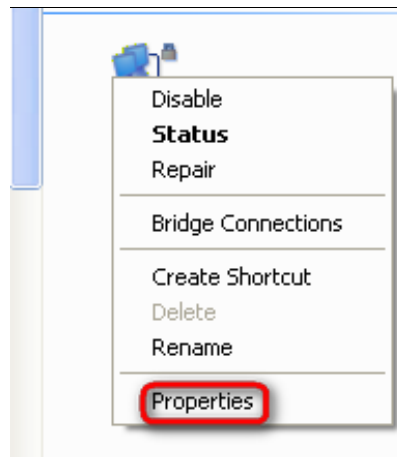

- 3 Scroll down to find and double click **Internet Protocol (TCP/IP)**.

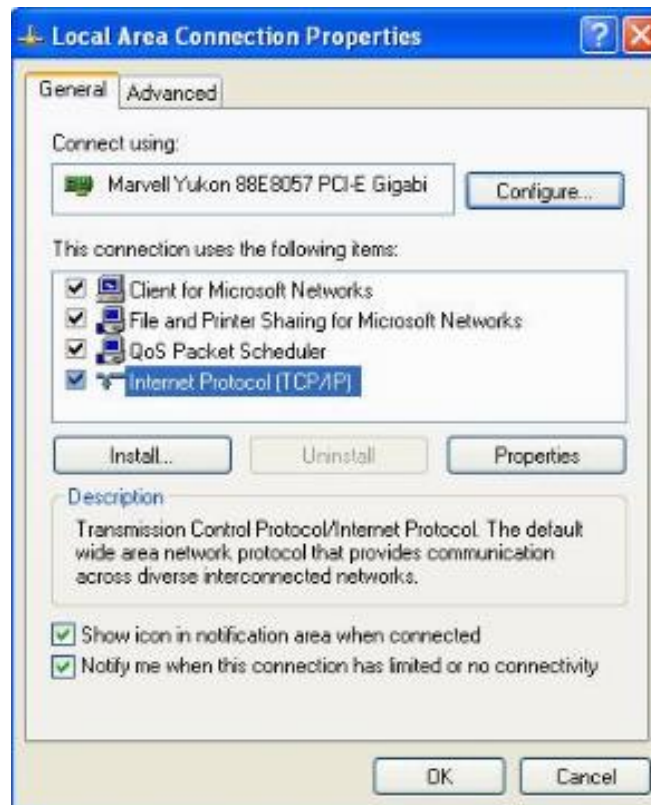

- 4 Select **Use the following IP address**, type in the IP address: **192.168.2.x** (2~253), Subnet mask: **255.255.255.0** and click **OK**.

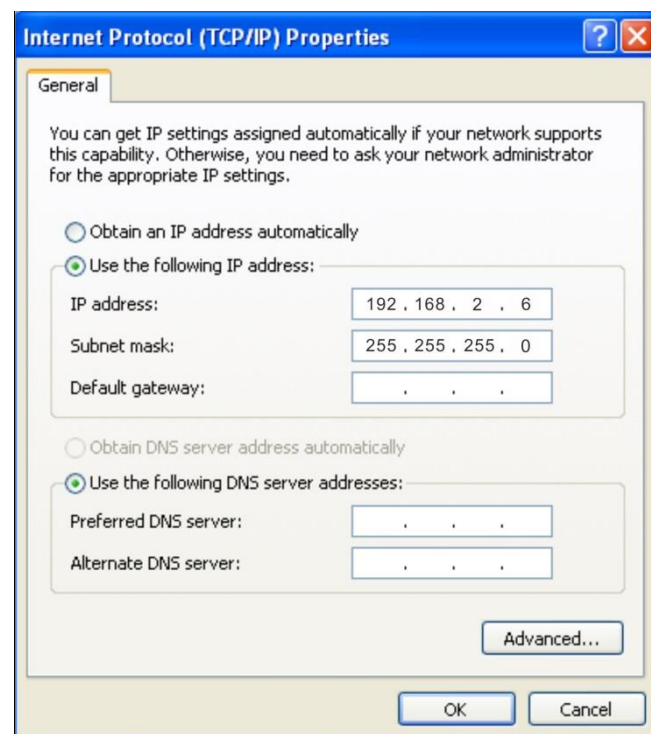

- 5 Click **OK** on the **Local Area Connection Properties** window.

## 2 Connect to Your WiFi



### Tip

1. The PC you use must have an installed wireless network adapter.
2. The device's SSID is "Tenda\_XXXXXX" by default (where "XXXXXX" is the last six characters of its MAC address). You can find the MAC address and SSID on the label attached to the device's bottom).
3. The first time you connect to your WiFi to configure the AP, you need to set your PC to **Use the following IP address**. For details, see Appendix [1 Configure PC](#). After finishing configuring the AP, you need to re-connect to your WiFi and set your PC to **Obtain an IP address automatically** for Internet access.

## Windows 8

**Step 1:** Click the icon  on the bottom right corner of your desktop.

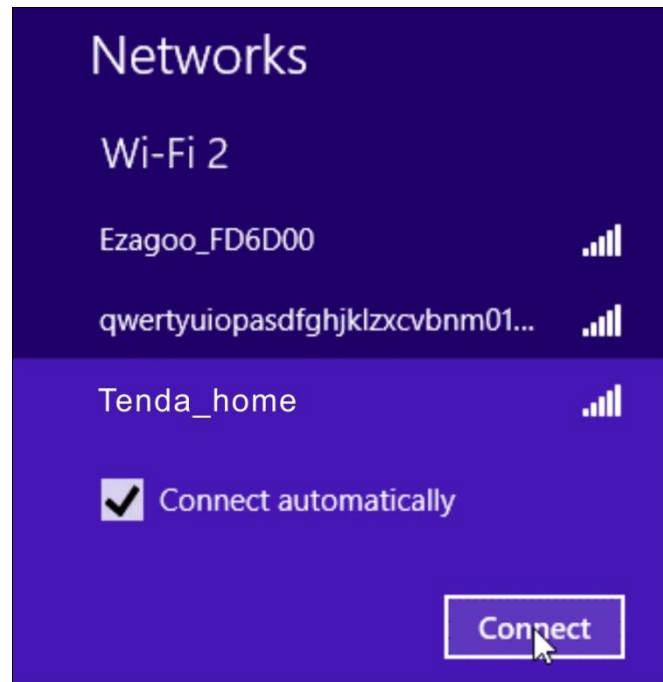

**Step 2:** Select your wireless network from the list, click **Connect** and then follow onscreen instructions.

**Tip**

1. If you cannot find the icon , please move your mouse to the top right corner of your desktop, select **Settings > Control Panel > Network and Internet > Network and Sharing Center > Change adapter settings**, right click **Wi-Fi** and select **Connect/Disconnect**.
2. If you cannot find your wireless network from the list, ensure the Airplane Mode is not enabled on your PC.

**Step 3:** When your wireless network is connected successfully, the following screen will appear.

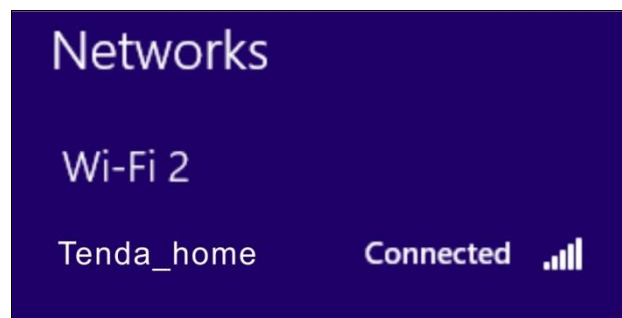

## Windows 7

**Step 1:** Click the icon  on the bottom right corner of your desktop.

**Step 2:** Double click your SSID (wireless network name) and then follow onscreen instructions.



**Step 3:** When your SSID (wireless network name) displays **Connected** as shown below, you've connected to it for Internet access successfully.





## Windows XP

**Step 1:** Right click **My Network Places**, and select **Properties**.

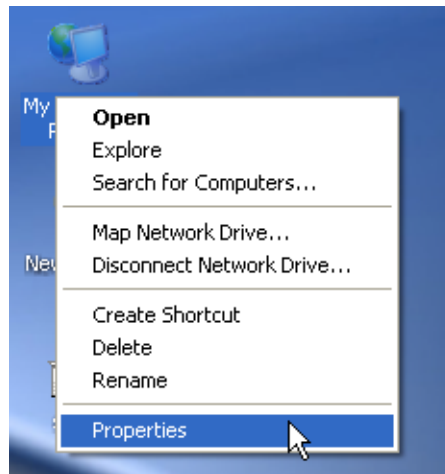

**Step 2:** Right click **Wireless Network Connection**, and select **View Available Wireless Networks** from the pop-up submenu.

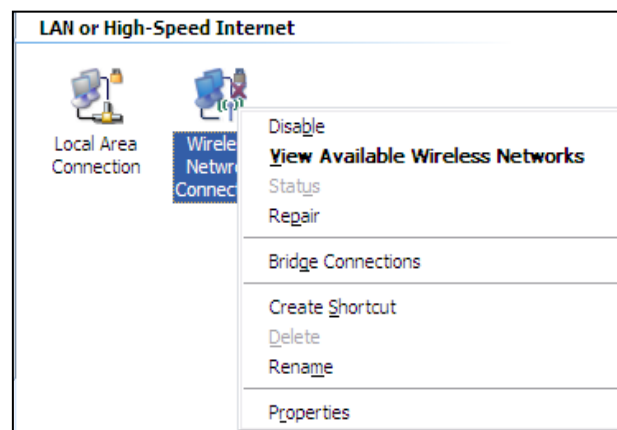

**Step 3:** Select your wireless network from the list and then follow onscreen instructions.

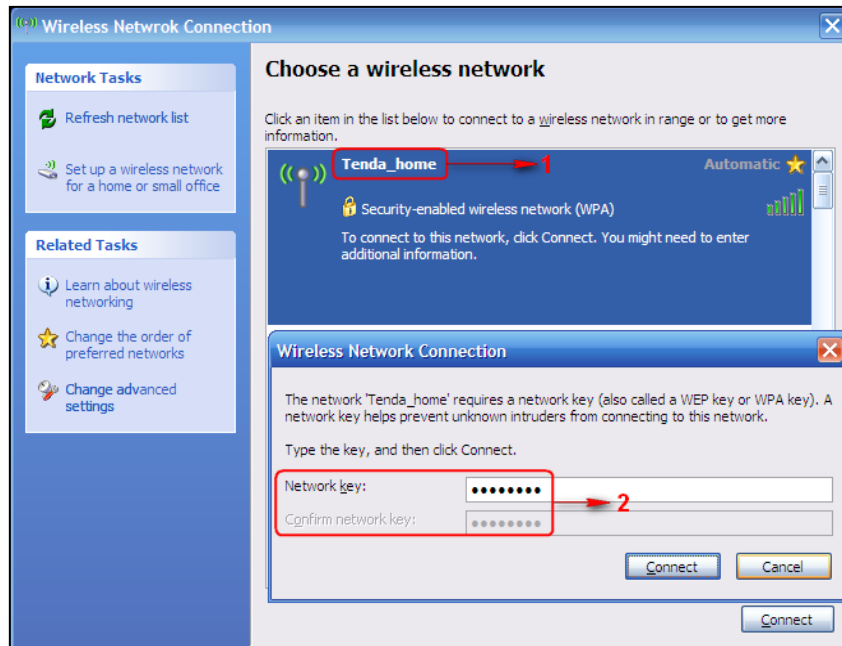

**Step 4:** When your SSID displays **Connected** as shown below, you've connected to it successfully.

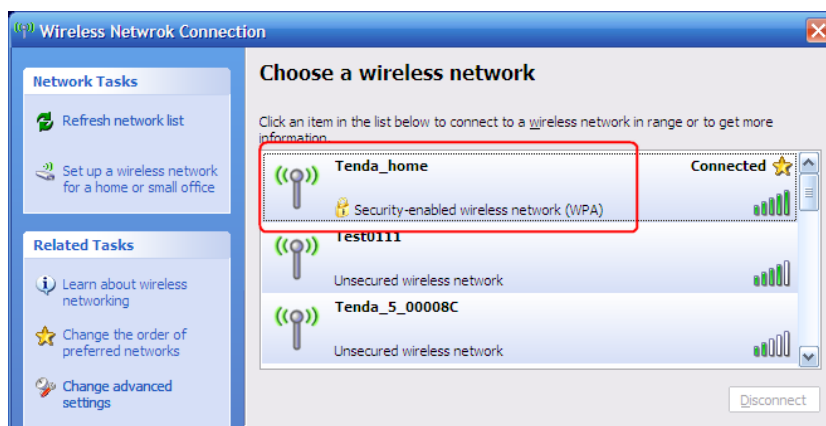

---

### 3 FAQs

**Q: I enter the device's LAN IP address in the web browser but cannot access this device's web UI. What should I do?**

- 1) Verify that the IP address of computer should be a different one but on the same network segment as the LAN IP address of this device. The default LAN IP address of AP is 192.168.2.1 and you need to set your PC to a static IP address within the following range: 192.168.2.X (2~253);
- 2) Clear the browser cookies or try another web browser;

If you are still unable to login, please restore the device to factory default settings and follow this Install Guide to configure your settings again.

### 4 Safety and Emission Statement



#### CE Mark Warning

This is a Class B product. In a domestic environment, this product may cause radio interference, in which case the user may be required to take adequate measures. This device complies with EU 1999/5/EC.

NOTE: (1) The manufacturer is not responsible for any radio or TV interference caused by unauthorized modifications to this equipment. (2) To avoid unnecessary radiation interference, it is recommended to use a shielded RJ45 cable.



#### FCC Statement

This device complies with Part 15 of the FCC Rules. Operation is subject to the following two conditions: (1) This device may not cause harmful interference, and (2) this device must accept any interference received, including interference that may cause undesired operation.

This equipment has been tested and found to comply with the limits for a Class B digital device, pursuant to Part 15 of the FCC Rules. These limits are designed to provide reasonable protection against harmful interference in a residential installation. This equipment generates, uses and can radiate radio frequency energy and, if not installed and used in accordance with the instructions, may cause harmful interference to radio communications. However, there is no guarantee that interference will not occur in a particular installation. If this equipment does cause harmful

interference to radio or television reception, which can be determined by turning the equipment off and on, the user is encouraged to try to correct the interference by one of the following measures:

- Reorient or relocate the receiving antenna.
- Increase the separation between the equipment and receiver.
- Connect the equipment into an outlet on a circuit different from that to which the receiver is connected.
- Consult the dealer or an experienced radio/TV technician for help.

**FCC Caution:** Any changes or modifications not expressly approved by the party responsible for compliance could void the user's authority to operate this equipment.

This transmitter must not be co-located or operating in conjunction with any other antenna or transmitter.

The manufacturer is not responsible for any radio or TV interference caused by unauthorized modifications to this equipment.

**Radiation Exposure Statement**

This equipment complies with FCC radiation exposure limits set forth for an uncontrolled environment. This equipment should be installed and operated with minimum distance 20cm between the radiator & your body.

NOTE: (1) The manufacturer is not responsible for any radio or TV interference caused by unauthorized modifications to this equipment. (2) To avoid unnecessary radiation interference, it is recommended to use a shielded RJ45 cable.